













BÉQUILLES ET ROSACES /
DEURKRUKKEN EN ROZETTEN

locomoson

Specialists in interior & furniture design accessories

59.106 – P – 0202

									
59106P0202	50	8	63	120	16	Noir Mat / Mat Zwart	0202		



59.106-P/BB-0202

Prix avantageux
par set













59.106-P/PZ-0202

Aantrekkelijke
prijs per set



59.106-P/WC-0202

59.124 – P – 0202

									
59124P0202	50	8	52	120	20...8	Noir Mat / Mat Zwart	0202		

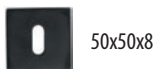

59.124-P/BB-0202

Prix avantageux
par set













59.124-P/PZ-0202

Aantrekkelijke
prijs per set



59.124-P/WC-0202

59.126 – P – 0202

									
59126P0202	50	8	53	120	26...8	Noir Mat / Mat Zwart	0202		

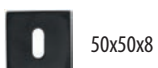

59.126-P/BB-0202

Prix avantageux
par set



59.126-P/PZ-0202

Aantrekkelijke
prijs per set



59.126-P/WC-0202

59.128 – P – 0202

59128P0202	50	8	50	155	28...8	Noir Mat / Mat Zwart	0202



50x50x8

59.128-P/BB-0202

Prix avantageux
par set



50x50x8

59.128-P/PZ-0202

Aantrekkelijke
prijs per set



50x50x8

59.128-P/WC-0202

59.729 – P – 0202

59729P0202	55	8	68	132	19	Noir Mat / Mat Zwart	0202



55x55x8

59.729-P/BB-0202

Prix avantageux
par set



55x55x8

59.729-P/PZ-0202

Aantrekkelijke
prijs per set



55x55x8

59.729-P/WC-0202

59.227 – P – 0202

59227P0202	50	5	63	108	16	Noir Mat / Mat Zwart	0202



50x50x5

59.227-P/BB-0202

Prix avantageux
par set



50x50x5

59.227-P/PZ-0202

Aantrekkelijke
prijs per set



50x50x5

59.227-P/WC-0202

59.228 – P – 0202



59228P0202	50	5	63	108	16	Noir Mat / Mat Zwart	0202
59228P0202	50	5	63	95	16	Noir Mat / Mat Zwart	0202



50x50x5

59.228-P/BB-0202

Prix avantageux
par set



50x50x5

59.228-P/PZ-0202

Aantrekkelijke
prijs per set



50x50x5

59.228-P/WC-0202

59.789 – P – 0202



59789P0202	42	8	70	106	18...21	Noir Mat / Mat Zwart	0202
------------	----	---	----	-----	---------	----------------------	------



42x42x8

59.789-P/BB-0202

Prix avantageux
par set



42x42x8

59.789-P/PZ-0202

Aantrekkelijke
prijs per set



42x42x8

59.789-P/WC-0202

59.130 – 20 – 0202

Arrêt de porte - Deurstop



59130200202	20	30	Noir Mat / Zwart Mat		0202
-------------	----	----	----------------------	--	------



59.132 – 25 – 0202

Arrêt de porte - Deurstop



59132250202	25	35	Noir Mat / Zwart Mat		0202
-------------	----	----	----------------------	--	------



59.011 – 0202

590110202	50	8	Noir Mat / Mat Zwart	0202	



59.012 – 0202

590120202	50	8	Noir Mat / Mat Zwart	0202	



59.211 – 0202 pour - voor 59.227 59.228

592110202	50	5	Noir Mat / Mat Zwart	0202	



59.212 – 0202 pour - voor 59.227 59.228

592120202	50	5	Noir Mat / Mat Zwart	0202	



59.311 – 0202 pour - voor 59.789

593110202	42	8	Noir Mat / Mat Zwart	0202	



59.312 – 0202 pour - voor 59.789

593120202	42	8	Noir Mat / Mat Zwart	0202	



59.411 – 0202

594110202	50	8	Noir Mat / Mat Zwart	0202	



59.412 – 0202

594120202	50	8	Noir Mat / Mat Zwart	0202	



59.014 – P08 – 0202



59014P080202

50

8

30

Noir Mat / Mat Zwart

0202



59.013 – P05 – 0202

pour - voor 59.227 59.228



59013P050202

50

5

45

Noir Mat / Mat Zwart

0202



59.213 – P08 – 0202

pour - voor 59.789



59213P080202

42

8

45

Noir Mat / Mat Zwart

0202



59.414 – P08 – 0202

pour - voor 59.106 59.124



59414P080202

50

8

30

Noir Mat / Mat Zwart

0202



59.413 – P08 – 0202

pour - voor 59.126



59413P080202

50

8

30

Noir Mat / Mat Zwart

0202



59.415 – P08 – 0202

pour - voor 59.128



59415P080202

50

8

30

Noir Mat / Mat Zwart

0202



09.016 – P – 0885



INOX AISI 304



09016P0885 50 4 55 120 16 Inox Brossé / Geborsteld RVS 0885

Pour voir  voir zie P 104-105



09.017 – P – 0885



INOX AISI 304



09017P0885 50 4 55 130 16 Inox Brossé / Geborsteld RVS 0885

Pour voir  voir zie P 104-105



09.036 – P – 0885



INOX AISI 304



09036P0885 50 4 55 120 16 Inox Brossé / Geborsteld RVS 0885

Pour voir  voir zie P 104-105



09.816 – P – 0885



INOX AISI 304



09816P0885 50 8 59 120 16 Inox Brossé / Geborsteld RVS 0885

Pour voir  voir zie P 104-105



09.814 – P – 0885



INOX AISI 304



09814P0885 50 8 58 118 16 Inox Brossé / Geborsteld RVS 0885

Pour voir  voir zie P 104-105



09.728 – P – 0885



INOX AISI 304



09728P0885 50 7 67 125 19 Inox Brossé / Geborsteld RVS 0885

Pour voir P 104-105



09.729 – P – 0885



INOX AISI 304



09729P0885 50 7 65 130 19 Inox Brossé / Geborsteld RVS 0885

Pour voir P 104-105



09.730 – P – 0885



INOX AISI 304



09730P0885 50 7 62 140 19 Inox Brossé / Geborsteld RVS 0885

Pour voir P 104-105



09.731 – P – 0885



INOX AISI 304



09731P0885 50 7 67 135 19 Inox Brossé / Geborsteld RVS 0885

Pour voir P 104-105



09.112 – P – 0885



INOX AISI 304

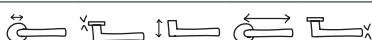

09112P0885 50 8 58 128 16...18 Inox Brossé / Geborsteld RVS 0885

Pour voir P 104-105



09.769 – P – 0885



INOX AISI 304



09769P0885

50

8

57

120

22x5

Inox Brossé / Geborsteld RVS

0885



09.050 – P – 0885



INOX AISI 304



09050P0885

50

8

53

125

10

Inox Brossé / Geborsteld RVS

0885



09.051 – P – 0885



INOX AISI 304



09051P0885

50

8

53

125

10

Inox Brossé / Geborsteld RVS

0885



09.815 – P – 0885



INOX AISI 304



09815P0885

50

8

58

128

16

Inox Brossé / Geborsteld RVS

0885

Pour
Voor



voir
zie

P 104-105



09.817 – P – 0885



INOX AISI 304

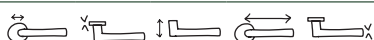

09817P0885

50

8

58

121

16

Inox Brossé / Geborsteld RVS

0885

Pour
Voor



voir
zie

P 104-105



09.144 – P – 0885



INOX AISI 304



09144P0885 50 8 55 100 20 Inox Brossé / Geborsteld RVS 0885

Pour voir  voir zie P 104-105



09.145 – P – 0885



INOX AISI 304



09145P0885 50 8 70 148 20 Inox Brossé / Geborsteld RVS 0885

Pour voir  voir zie P 104-105



09.226 – P – 0885



INOX AISI 304



09226P0885 50 8 58 100 18 Inox Brossé / Geborsteld RVS 0885

Pour voir  voir zie P 104-105



09.227 – P – 0885



INOX AISI 304



09227P0885 50 8 58 125 18 Inox Brossé / Geborsteld RVS 0885

Pour voir  voir zie P 104-105



09.052 – P – 0885



INOX AISI 304

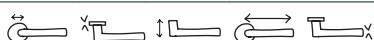

09052P0885 50 8 65 70 19 Inox Brossé / Geborsteld RVS 0885

Pour voir  voir zie P 104-105



09.830 – P – 0885



INOX AISI 304



09830P0885

50

8

55

140

16

Inox Brossé / Geborsteld RVS

0885

Pour voir
Voor zie  voir zie P 104-105



Silicone

09.831 – P – 0885



INOX AISI 304



09831P0885

50

8

55

140

16

Inox Brossé / Geborsteld RVS

0885

Pour voir
Voor zie  voir zie P 104-105



Silicone

09.832 – P – 0885



INOX AISI 304



09832P0885

50

8

55

140

16

Inox Brossé / Geborsteld RVS

0885

Pour voir
Voor zie  voir zie P 104-105



Silicone

09.833 – P – 0885



INOX AISI 304



09833P0885

50

8

55

140

16

Inox Brossé / Geborsteld RVS

0885

Pour voir
Voor zie  voir zie P 104-105



Silicone

09.834 – P – 0885



INOX AISI 304



09834P0885

50

8

55

140

16

Inox Brossé / Geborsteld RVS

0885

Pour voir
Voor zie  voir zie P 104-105



Silicone

09.311 – P – 0280 – 0885



INOX AISI 304



09311P02800885	50	8	55	120	30...5	Inox Brossé / Geborsteld RVS Chrome Mat / Mat Chroom	0885 0280
----------------	----	---	----	-----	--------	---	--------------



09.312 – P – 0180 – 0885



INOX AISI 304

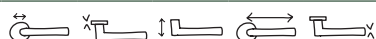

09312P01800885	50	8	55	120	30...5	Inox Brossé / Geborsteld RVS Chrome Mat / Mat Chroom	0885 0180
----------------	----	---	----	-----	--------	---	--------------



09.314 – P – 0101 – 0885



INOX AISI 304

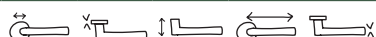

09314P01010885	50	8	55	120	30...5	Inox Brossé / Geborsteld RVS Chrome Mat / Mat Chroom	0885 0101
----------------	----	---	----	-----	--------	---	--------------



09.316 – P – 0202 – 0885



INOX AISI 304

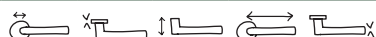

09316P01020885	50	8	55	120	30...5	Inox Brossé / Geborsteld RVS Noir Mat / Mat Zwart	0885 0202
----------------	----	---	----	-----	--------	--	--------------



09.077 – P – 0885



INOX AISI 304

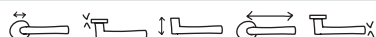

09077P0885	50	8	53	120	12...22	Inox Brossé / Geborsteld RVS	0885
------------	----	---	----	-----	---------	------------------------------	------

Pour voir
Voor zie  P 104-105



09.106 – P8 – 0885



INOX AISI 304



09106P80885 50 9 53 125 10 Inox Brossé / Geborsteld RVS 0885

Pour voir  voir zie P 104-105

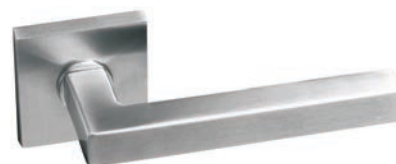

09.122 – P – 0885



INOX AISI 304

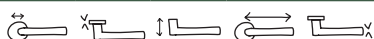

09122P0885 50 9 53 135 22 Inox Brossé / Geborsteld RVS 0885

Pour voir  voir zie P 104-105

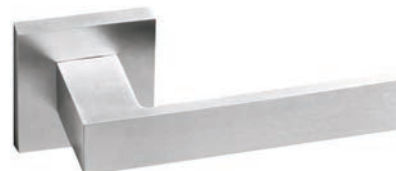

09.108 – P – 0885



INOX AISI 304

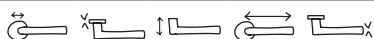

09108P0885 50 8 45 120 19 Inox Brossé / Geborsteld RVS 0885

Pour voir  voir zie P 104-105



09.107 – P –



INOX AISI 304

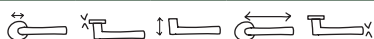

09107P0885 50 8 48 130 22x11 Inox Brossé / Geborsteld RVS **0885**
09107P0185 50 8 48 130 22x11 Inox Poli / Gepolijst RVS **0185**

Pour voir  voir zie P 104-105



09.849 – P – 0885



INOX AISI 304



09849P0885 50 8 62 135 20x12 Inox Brossé / Geborsteld RVS 0885

Pour voir  voir zie P 104-105



DRIVE



DOCUMENTATION SUR DEMANDE
DOCUMENTATIE OP AANVRAAG

09.225 – P – 2102 – 0885



INOX AISI 304



09225P21020885 50 8 53 135 19 Inox Brossé / Geborsteld RVS 0885



09.225 – P – 2105 – 0885



INOX AISI 304



09225P21050885 50 8 53 135 19 Inox Brossé / Geborsteld RVS 0885



09.225 – P – 2101 – 0885



INOX AISI 304



09225P21010885 50 8 53 135 19 Inox Brossé / Geborsteld RVS 0885



09.401 – P – 0885



INOX AISI 304



09401P0885 50 8 46 121 21 Inox Brossé / Geborsteld RVS 0885



09.402 – P – 0885



INOX AISI 304



09402P0885 50 8 46 121 21 Inox Brossé / Geborsteld RVS 0885



09.403 – P – 0885



INOX AISI 304

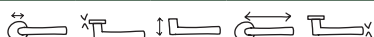

09403P0885 50 8 46 121 21 Inox Brossé / Geborsteld RVS 0885





**ARCHITECTURAL
HARDWARE**

09.445 – P – 0885



INOX AISI 304

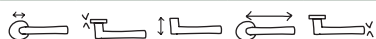

09445P0885 50 8 46 121 21 Inox Brossé / Geborsteld RVS 0885



09.446 – P – 0885



INOX AISI 304

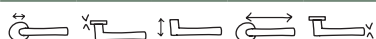

09446P0885 50 8 46 121 21 Inox Brossé / Geborsteld RVS 0885



09.406 – P – 0885



INOX AISI 304



09406P0885 50 8 46 121 21 Inox Brossé / Geborsteld RVS 0885



ANTIBACTERIAL

09.409 – P – 0885



INOX AISI 304



09409P0885 50 8 46 121 21 Inox Brossé / Geborsteld RVS 0885



ANTIBACTERIAL

09.440 – P – 0885



INOX AISI 304



09440P0885 50 8 46 121 21 Inox Brossé / Geborsteld RVS 0885



- *La majorité des béquilles de la collection 09 peut être commandée sur plaque.*

Veillez nous consulter pour toute offre.

- *De meeste deurkrukken van de 09 collectie kunnen met een plaat besteld worden.*

Contacteer ons voor een vrijblijvende offerte.

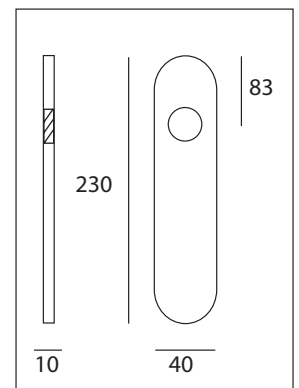
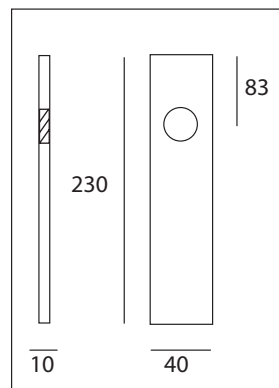
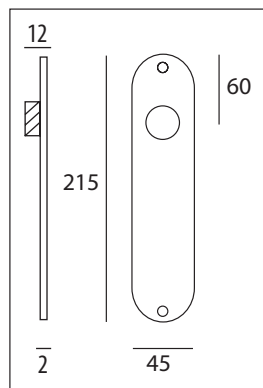
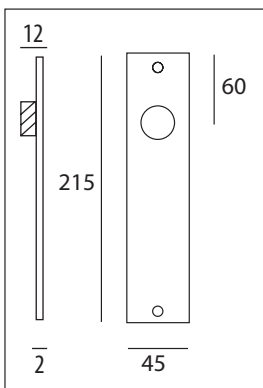

09.591

09.597

09.598

09.599

09.011 – – 0885



INOX AISI 304



0901140885	50	4	Inox Brossé / Geborsteld RVS	0885
0901170885	50	7	Inox Brossé / Geborsteld RVS	0885
0901180885	50	8	Inox Brossé / Geborsteld RVS	0885



09.012 – – 0885



INOX AISI 304

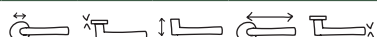

0901240885	50	4	Inox Brossé / Geborsteld RVS	0885
0901270885	50	7	Inox Brossé / Geborsteld RVS	0885
0901280885	50	8	Inox Brossé / Geborsteld RVS	0885



09.018 – 0885



INOX AISI 304

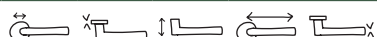

090180885	50	7	Inox Brossé / Geborsteld RVS	0885
-----------	----	---	------------------------------	------



09.011 – OV – 0885



INOX AISI 304

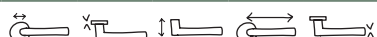

090110V0885	30...60	8	Inox Brossé / Geborsteld RVS	0885
-------------	---------	---	------------------------------	------



09.012 – OV – 0885



INOX AISI 304

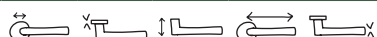

090120V0885	30...60	7	Inox Brossé / Geborsteld RVS	0885
-------------	---------	---	------------------------------	------



09.019 – OV – 0885



INOX AISI 304



090190V0885	28...62	11	Inox Brossé / Geborsteld RVS	0885
-------------	---------	----	------------------------------	------



09.166 – P – 0885



INOX AISI 304

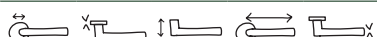

09166P0885	55	15	Inox Brossé / Geborsteld RVS	0885
------------	----	----	------------------------------	------



09.013 – P08 – 0885



INOX AISI 304



09013P080885 50 8 29 Inox Brossé / Geborsteld RVS 0885



09.014 – P08 – 0885



INOX AISI 304



09014P080885 50 8 29 Inox Brossé / Geborsteld RVS 0885



09.014 – P04 – 0885



INOX AISI 304



09014P040885 50 4 21 Inox Brossé / Geborsteld RVS 0885



09.213 – P08 – 0885



INOX AISI 304



09213P080885 50 8 36 Inox Brossé / Geborsteld RVS 0885



09.114 – P08 – 0885



INOX AISI 304



09114P080885 50 8 36 Inox Brossé / Geborsteld RVS 0885



09.214 – P08 – 0885



INOX AISI 304



09214P080885 50 8 42 Inox Brossé / Geborsteld RVS 0885



09.411 – 0885



INOX AISI 304



094110885 50 8 Inox Brossé / Geborsteld RVS 0885



09.412 – 0885



INOX AISI 304



094120885 50 8 Inox Brossé / Geborsteld RVS 0885



09.413 – P08 – 0885



INOX AISI 304



09413P080885 50 8 30 Inox Brossé / Geborsteld RVS 0885

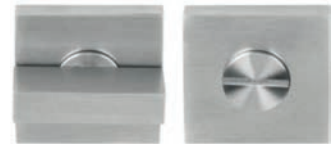

09.414 – P08 – 0885



INOX AISI 304



09414P080885 50 8 30 Inox Brossé / Geborsteld RVS 0885

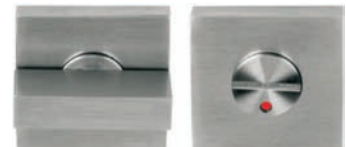

09.420 – P08 – 0885



INOX AISI 304

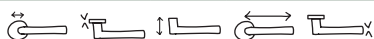

09420P080885 50 8 33 Inox Brossé / Geborsteld RVS 0885





LESS IS MORE



INOX AISI 304



Rosace ronde / Ronde rozet
09.501 - P35/40 - 0885

✂ Épaisseur porte : 35 / 40 mm
Deurdikte : 35 / 40 mm

09.501 - P45/50 - 0885
✂ Épaisseur porte : 45 / 50 mm
Deurdikte : 45 / 50 mm

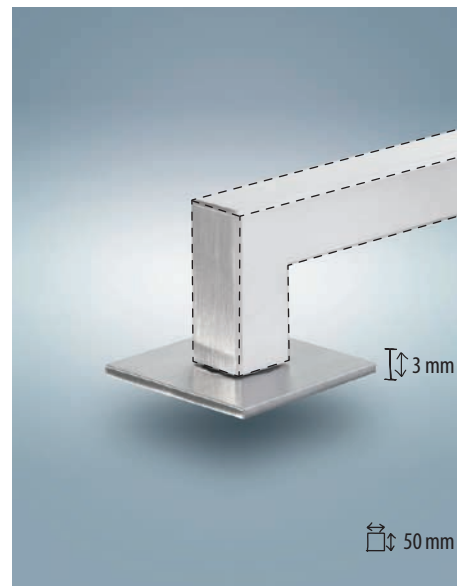

Rosace carrée / Vierkante rozet
09.601 - P35/40 - 0885

✂ Épaisseur porte : 35 / 40 mm
Deurdikte : 35 / 40 mm

09.601 - P45/50 - 0885
✂ Épaisseur porte : 45 / 50 mm
Deurdikte : 45 / 50 mm

Less is More se combine avec la plupart des modèles de béquilles de porte de la collection 09.
Less is More combineert zich met de meeste deurkrukmodellen van de 09 collectie.

1. Vis Allen / Inbusvijs,
2. Béquille / Deurkruk,
3. Bague / Ring,
4. Rosace inox / RVS rozet,
5. Vis M4 / Schroef M4,
6. Base métallique / Metaalbasis,
7. Carré 8 x 8 mm / Vierkante stift 8 x 8 mm.



LESS IS MORE



INOX AISI 304

09.511 - P - 0885

Paire de rosaces clé Acier Inox Brossé
Paar sleutelrozetten Geborsteld RVS

09511P0885

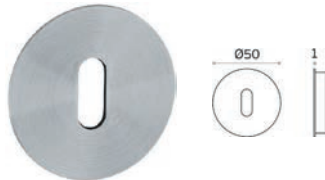

09.512 - P - 0885

Paire de rosaces cylindre Acier Inox Brossé
Paar cylinderrozetten Geborsteld RVS

09512P0885



09.513 - P 35/40 - 0885

Ensemble WC Acier Inox Brossé (épaisseur porte : 35 / 40 mm)
WC sluiting Geborsteld RVS (deurdikte : 35 / 40 mm)

09513P35400885



09.513 - P 45/50 - 0885

Ensemble WC Acier Inox Brossé (épaisseur porte : 45 / 50 mm)
WC sluiting Geborsteld RVS (deurdikte : 45 / 50 mm)

09513P45500885

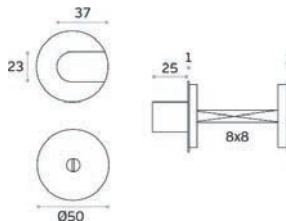

09.514 - P 35/40 - 0885

Ensemble WC + visu Acier Inox Brossé (épaisseur porte : 35 / 40 mm)
WC sluiting + visu Geborsteld RVS (deurdikte : 35 / 40 mm)

09514P35400885

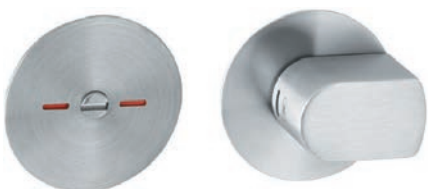

09.514 - P 45/50 - 0885

Ensemble WC + visu Acier Inox Brossé (épaisseur porte : 45 / 50 mm)
WC sluiting + visu Geborsteld RVS (deurdikte : 45 / 50 mm)

09514P45500885

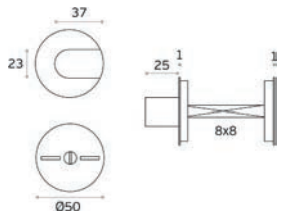

LESS IS MORE



INOX AISI 304

09.611 - P - 0885

Paire de rosaces clé Acier Inox Brossé
Paar sleutelrozetten Geborsteld RVS

09611P0885

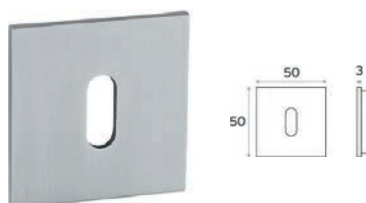

09.612 - P - 0885

Paire de rosaces cylindre Acier Inox Brossé
Paar cylinderrozetten Geborsteld RVS

09612P0885

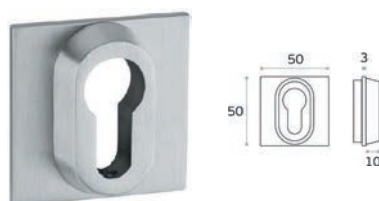

09.613 - P 35/40 - 0885

Ensemble WC Acier Inox Brossé (épaisseur porte : 35 / 40 mm)
WC sluiting Geborsteld RVS (deurdikte : 35 / 40 mm)

09613P35400885



09.613 - P 45/50 - 0885

Ensemble WC Acier Inox Brossé (épaisseur porte : 45 / 50 mm)
WC sluiting Geborsteld RVS (deurdikte : 45 / 50 mm)

09613P45500885

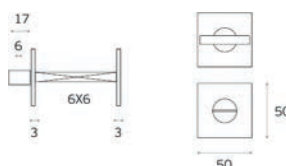



EVEN LESS



INOX AISI 304



Rosace ronde / Ronde rozet
09.701-P-0885

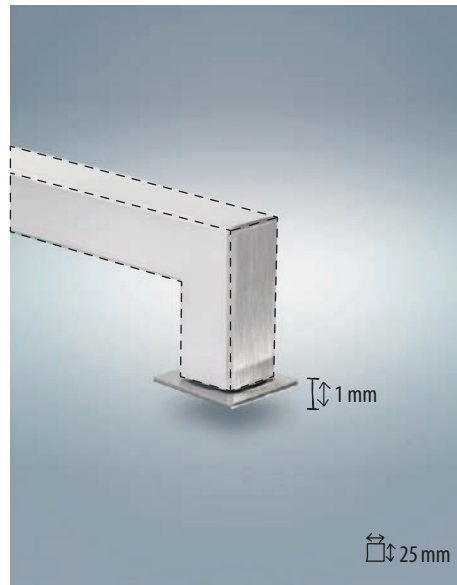

Rosace carrée / Vierkante rozet
09.801-P-0885

Even Less se combine avec la plupart des modèles de béquilles de porte de la collection 09.
Even Less combineert zich met de meeste deurkrukmodellen van de 09 collectie.

1. Vis Allen / Inbusvijs,
2. Béquille / Deurkruk,
3. Bague / Ring,
4. Rosace inox / RVS rozet,
5. Carré 8 x 8 mm / Vierkante stift 8 x 8 mm.



EVEN LESS



INOX AISI 304

09.711 - P - 0885

Paire de rosaces clé Acier Inox Brossé
Paar sleutelrozetten Geborsteld RVS

09711P0885



09.811 - P - 0885

Paire de rosaces clé Acier Inox Brossé
Paar sleutelrozetten Geborsteld RVS

09811P0885



09.712 - P - 0885

Paire de rosaces cylindre Acier Inox Brossé
Paar cylinderrozetten Geborsteld RVS

09712P0885

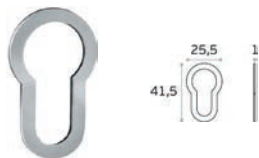

09.812 - P - 0885

Paire de rosaces cylindre Acier Inox Brossé
Paar cylinderrozetten Geborsteld RVS

09812P0885



09.713 - P 35/40 - 0885

Ensemble WC Acier Inox Brossé (épaisseur porte : 35 / 40 mm)
WC sluiting Geborsteld RVS (deurdikte : 35 / 40 mm)

09713P35400885



09.713 - P 45/50 - 0885

Ensemble WC Acier Inox Brossé (épaisseur porte : 45 / 50 mm)
WC sluiting Geborsteld RVS (deurdikte : 45 / 50 mm)

09713P45500885



09.813 - P 35/40 - 0885

Ensemble WC Acier Inox Brossé (épaisseur porte : 35 / 40 mm)
WC sluiting Geborsteld RVS (deurdikte : 35 / 40 mm)

09813P35400885



09.813 - P 45/50 - 0885

Ensemble WC Acier Inox Brossé (épaisseur porte : 45 / 50 mm)
WC sluiting Geborsteld RVS (deurdikte : 45 / 50 mm)

09813P45500885

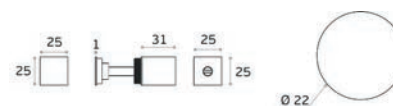

FERME - PORTES
DEURSLUITERS

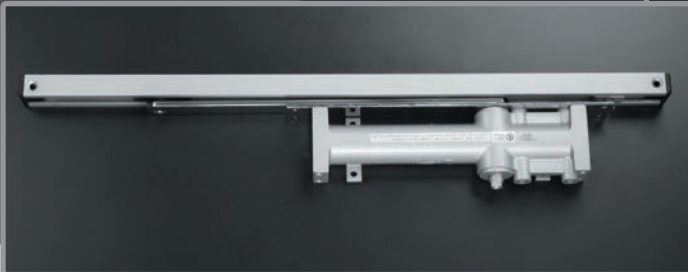
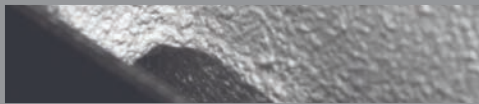
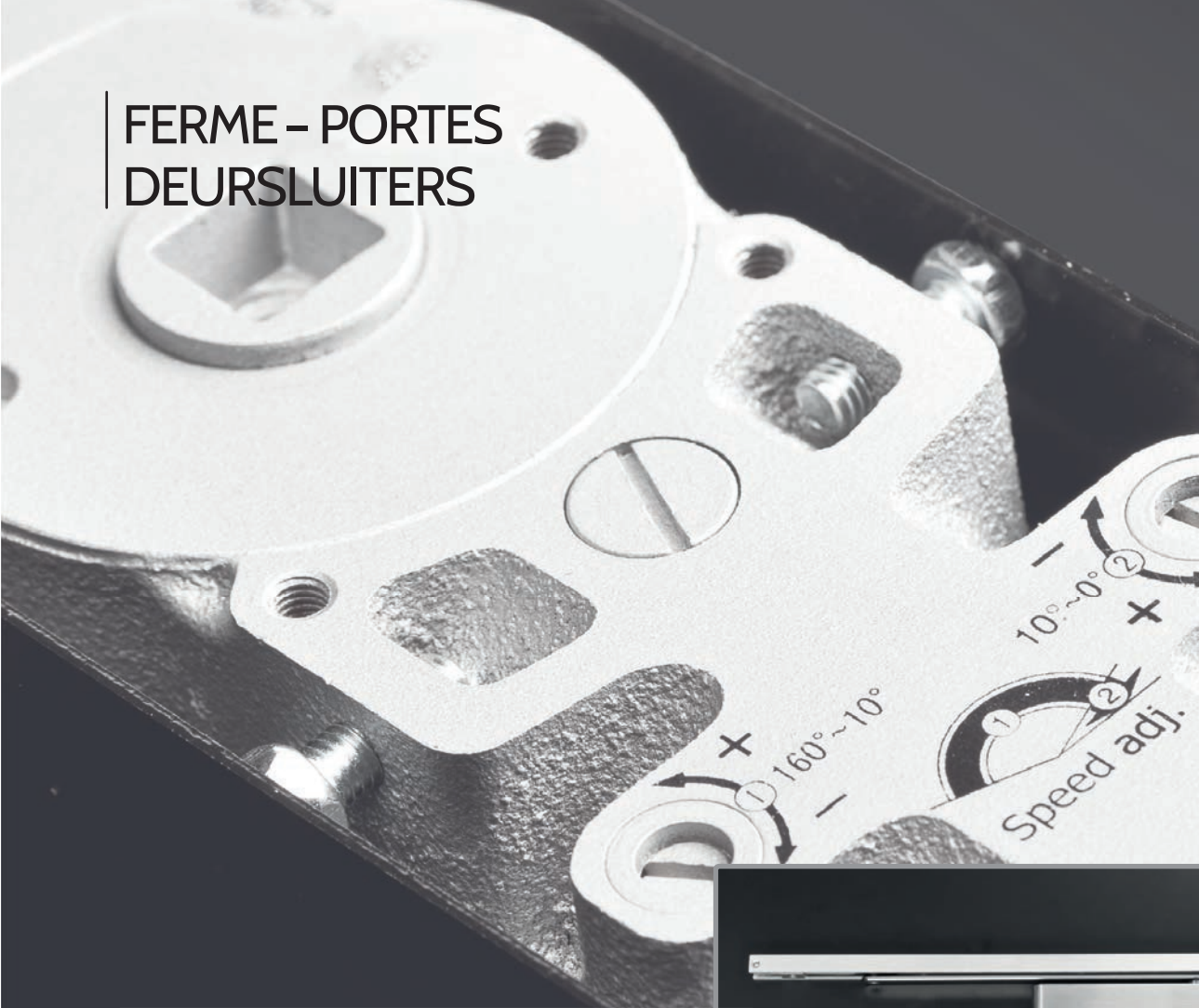



DOCUMENTATION SUR DEMANDE
DOCUMENTATIE OP AANVRAAG





09.MFO - - 0885

			
09MFO320885	32	Mécanisme de fenêtre Inox Brossé Raamkruk mechanisme Geborsteld RVS	0885
09MFO370885	37	Mécanisme de fenêtre Inox Brossé Raamkruk mechanisme Geborsteld RVS	
09MFO600885	60	Mécanisme de fenêtre Inox Brossé Raamkruk mechanisme Geborsteld RVS	

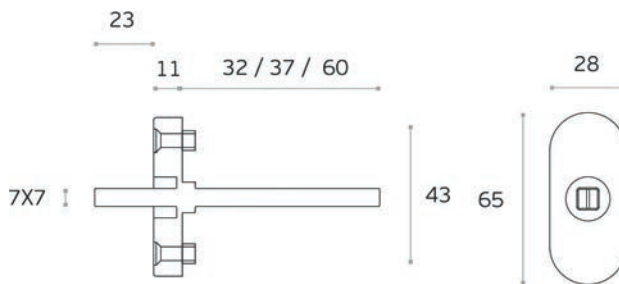

09.MFR - - 0885

			
09MFR320885	32	Mécanisme de fenêtre Inox Brossé Raamkruk mechanisme Geborsteld RVS	0885
09MFR370885	37	Mécanisme de fenêtre Inox Brossé Raamkruk mechanisme Geborsteld RVS	
09MFR600885	60	Mécanisme de fenêtre Inox Brossé Raamkruk mechanisme Geborsteld RVS	

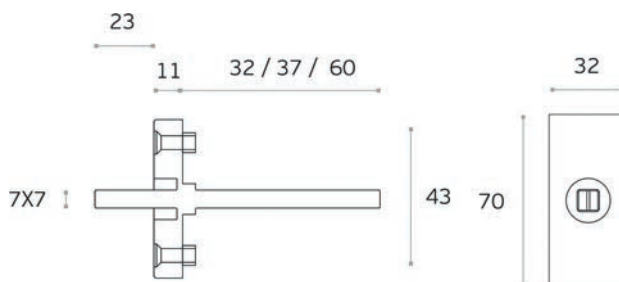

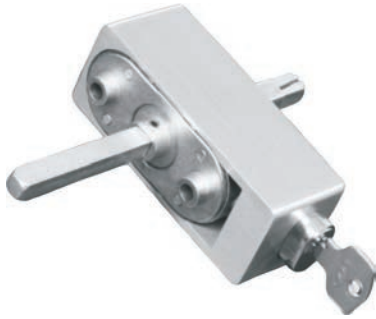

09.MFRC - 0885



09MFRC0885

55

Mécanisme de fenêtre + clé Inox Brossé
Raamkruk mechanisme + sleutel Geborsteld RVS

0885

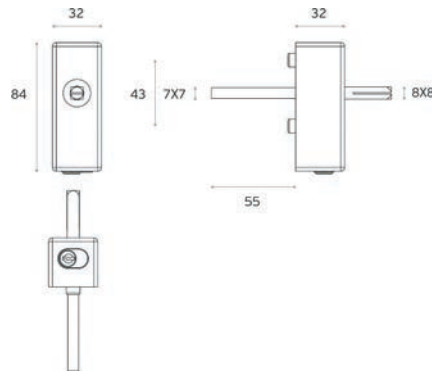

- Ces mécanismes se combinent avec la plupart des modèles de béquilles de porte de la collection 09.

Veillez nous consulter pour toute offre.

- Dit mechanisme combineert zich met de meeste deurkrukmodellen van de 09 collectie.

Contacteer ons voor een vrijblijvende offerte.

29.110 – F – 0885



INOX AISI 304



29110F0885 50 8 58 50 50 Inox Brossé / Geborsteld RVS 0885



29.110 – PM – 0885



INOX AISI 304



29110PM0885 50 8 58 50 50 Inox Brossé / Geborsteld RVS 0885



29.405 – F – 0885



INOX AISI 304



29405F0885 50 8 58 50 50 Inox Brossé / Geborsteld RVS 0885



29.405 – PM – 0885



INOX AISI 304



29405PM0885 50 8 58 50 50 Inox Brossé / Geborsteld RVS 0885



29.061 – F – 0885



INOX AISI 304

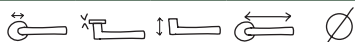

29061F0885 50 8 86 65 Inox Brossé / Geborsteld RVS 0885



29.061 – PM – 0885



INOX AISI 304

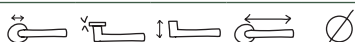

29061PM0885 50 8 86 65 Inox Brossé / Geborsteld RVS 0885



29.091-F-0885



INOX AISI 304

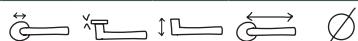

29091F0885 50 8 75 50 Inox Brossé / Geborsteld RVS 0885



29.091-PM-0885



INOX AISI 304

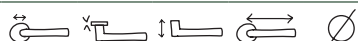

29091PM0885 50 8 75 50 Inox Brossé / Geborsteld RVS 0885



29.092-F-0885



INOX AISI 304

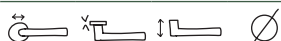

29092F0885 50 8 40 50 Inox Brossé / Geborsteld RVS 0885



29.092-PM-0885



INOX AISI 304

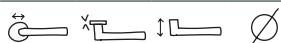

29092PM0885 50 8 40 50 Inox Brossé / Geborsteld RVS 0885



29.093-F-0885



INOX AISI 304

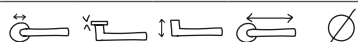

29093F0885 50 8? 72 50 Inox Brossé / Geborsteld RVS 0885



29.093-PM-0885



INOX AISI 304

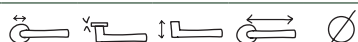

29093PM0885 50 8? 77 50 Inox Brossé / Geborsteld RVS 0885





19.282 - P - 0885

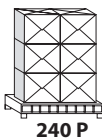

INOX AISI 201



+ 0 0

19282P0885 50 8 60 125 19 Inox Brossé / Geborsteld RVS 0885

19.302 - P - 0885

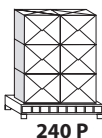

INOX AISI 201

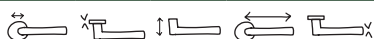

+ 0 0

19302P0885 50 8 60 125 19 Inox Brossé / Geborsteld RVS 0885

19.292 - P - 0885

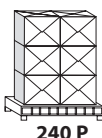

INOX AISI 201



+ 0 0

19292P0885 50 8 60 135 19 Inox Brossé / Geborsteld RVS 0885

19.122 - P - 0885

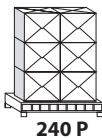

INOX AISI 201



+ 0 0

19122P0885 50 8 60 130 10...18 Inox Brossé / Geborsteld RVS 0885

19.200 - P - 0885

INOX AISI 201



19200P0885 50 8 Inox Brossé / Geborsteld RVS 0885

19.400 - P - 0885

INOX AISI 201



19400P0885 50 8 Inox Brossé / Geborsteld RVS 0885

19.204 - P - 0885

INOX AISI 201



19204P0885 50 8 35 Inox Brossé / Geborsteld RVS 0885

02.001-P-0885

INOX AISI 316



02001P0885 55 9 65 123 18 Inox Brossé / Geborsteld RVS 0885



02.004-P-0885

INOX AISI 304

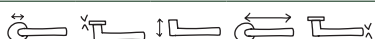

02004P0885 55 11 70 141 30 x 6 Inox Brossé / Geborsteld RVS 0885



02.002-P-0885

INOX AISI 304



02002P0885 55 11 65 132 18 Inox Brossé / Geborsteld RVS 0885



02.005-P-0181



02005P0181 55 13 57 126 Laiton Brillant / Glanzend Messing 0181



02.003-P-0885

INOX AISI 316

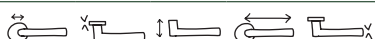

02003P0885 55 9 65 134 18 Inox Brossé / Geborsteld RVS 0885



02.007 - P - 0885

INOX AISI 316

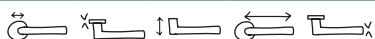

02007P0885 55 9 70 138 22 x 155 Inox Brossé / Geborsteld RVS 0885



02.008 - P - 0885

INOX AISI 316



02008P0885 55 9 65 132 20 x 12 Inox Brossé / Geborsteld RVS 0885



02.009 - P - 0885

INOX AISI 316



02009P0885 55 9 58 132 12 x 12 Inox Brossé / Geborsteld RVS 0885



02.010 - P - 0885

INOX AISI 316

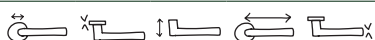

02010P0885 55 9 61 132 15 Inox Brossé / Geborsteld RVS 0885



02.015 - P - 0885

INOX AISI 316

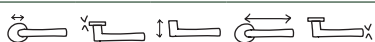

02015P0885 55 9 60 148 6...20...16 Inox Brossé / Geborsteld RVS 0885



02.017-P-0885

INOX AISI 304



02017P0885 55 9 58 127 22 x 15 Inox Brossé / Geborsteld RVS 0885



02.019-P-0885

INOX AISI 304



02019PQ0885 54 2 47 129 20 x 12 Inox Brossé / Geborsteld RVS 0885



02.006-P-0885-2003

INOX AISI 304



02006P08852003 55 9 63 132 20 Inox Brossé / Geborsteld RVS 0885-2003



02.006-P-0885-2004

INOX AISI 304



02006P08852004 55 9 63 132 20 Inox Brossé / Geborsteld RVS 0885-2004



02.006-P-0885-2005

INOX AISI 304



02006P08852005 55 9 63 132 20 Inox Brossé / Geborsteld RVS 0885-2005



02.006 – P – 0885 – 2008

INOX AISI 304



02006P08852008 55 9 63 132 20 Inox Brossé / Geborsteld RVS 0885-2008

02.006 – P – 0885 – 2009

INOX AISI 304



02006P08852009 55 9 63 132 20 Inox Brossé / Geborsteld RVS 0885-2009

02.006 – P – 0885 – 2085

INOX AISI 304



02006P08852085 55 9 63 132 20 Inox Brossé / Geborsteld RVS 0885-2085

02.006 – P – 0885 – 2086

INOX AISI 304



02006P08852086 55 9 63 132 20 Inox Brossé / Geborsteld RVS 0885-2086

02.006 – P – 0885 – 0101

INOX AISI 304



02006P08850101 55 9 63 132 20 Inox Brossé / Geborsteld RVS 0885-0101

02.006 – P – 0885 – 0102

INOX AISI 304



02006P08850102 55 9 63 132 20 Inox Brossé / Geborsteld RVS 0885-0102



02.006 – P – 0885 – 0113

INOX AISI 304



02006P08850113 55 9 63 132 20 Inox Brossé / Geborsteld RVS 0885-0113



49 – 100 – 0885

INOX AISI 304

Gabarit - Boormal



491000885 Inox Brossé / Geborsteld RVS 0885

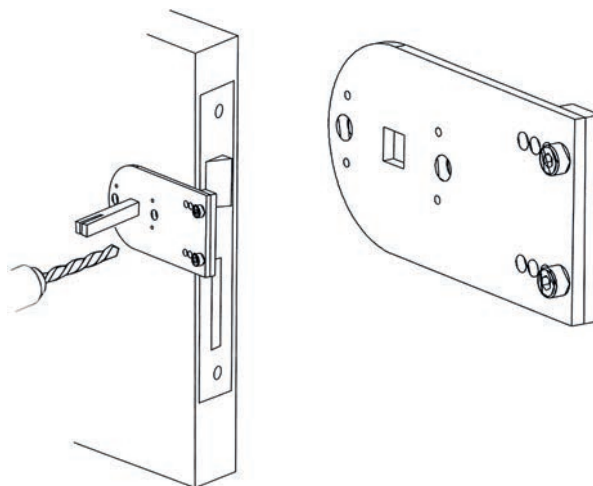

02.011 - 0885

INOX AISI 304



020110885 55 9 Inox Brossé / Geborsteld RVS 0885



02.012 - 0885

INOX AISI 304



020120885 55 9 Inox Brossé / Geborsteld RVS 0885



02.013 - P - 0885

INOX AISI 304



02013P0885 55 12 33 Inox Brossé / Geborsteld RVS 0885



02.014 - P - 0885

INOX AISI 304



02014P0885 55 12 33 Inox Brossé / Geborsteld RVS 0885



02.018 - 0885

INOX AISI 304



020180885 55 9 Inox Brossé / Geborsteld RVS 0885

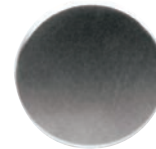

02.043 - 🖐️ - 0885

INOX AISI 304



02043PA0885 55 12 33 PA Inox Brossé / Geborsteld RVS 0885
02043PB0885 55 12 33 PB Inox Brossé / Geborsteld RVS 0885



A = Rechts / Droite



A = Rechts / Droite B = Links / Gauche

02.413 - 🖐️ - 0885

INOX AISI 304



02413PA0885	55	12	55	PA	Inox Brossé / Geborsteld RVS	0885
02413PB0885	55	12	55	PB	Inox Brossé / Geborsteld RVS	0885



A = Rechts / Droite

02.414 - 🖐️ - 0885

INOX AISI 304



02414PA0885	55	12	55	PA	Inox Brossé / Geborsteld RVS	0885
02414PB0885	55	12	55	PB	Inox Brossé / Geborsteld RVS	0885

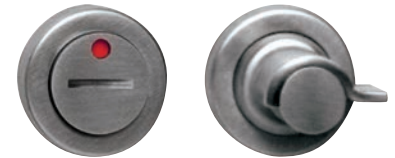

A = Rechts / Droite

02.011 - 0181



020110181	55	10			Laiton Brillant / Glanzend Messing	0181
-----------	----	----	--	--	------------------------------------	------



02.012 - 0181



020120181	55	10			Laiton Brillant / Glanzend Messing	0181
-----------	----	----	--	--	------------------------------------	------



02.013 - P - 0181



02013P0181	55	12	38	P	Laiton Brillant / Glanzend Messing	0181
------------	----	----	----	----------	------------------------------------	------



02.018 - 0181



020180181	55	10		P	Laiton Brillant / Glanzend Messing	0181
-----------	----	----	--	----------	------------------------------------	------



A = Rechts / Droite

B = Links / Gauche

02.411 - P - 0885

02411P0885	54	2				Inox Brossé / Geborsteld RVS	0885



02.412 - P - 0885

02412P0885	54	2				Inox Brossé / Geborsteld RVS	0885



02.415 - P - 0885

02415P0885	54	2	34				Inox Brossé / Geborsteld RVS	0885-0101



23.211 - T - 0885

							INOX AISI 304
232112000885	55	9	67	200	20	Inox Brossé / Geborsteld RVS	0885
232112500885	55	9	67	250	20	Inox Brossé / Geborsteld RVS	0885



23.061 - 60 - 0885

							INOX AISI 304	
23061600885	60	1	70				Inox Brossé / Geborsteld RVS	0885

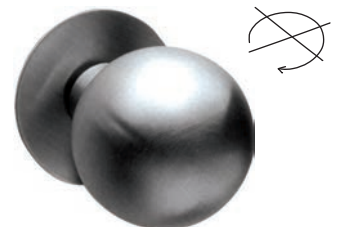

23.061 - M - 60 - 0885

							INOX AISI 304	
23061M600885	60	9	78	60			Inox Brossé / Geborsteld RVS	0885



23.061-F-60-0885

INOX AISI 304



23061F600885 60 9 78 60 Inox Brossé / Geborsteld RVS 0885



23.071-50-0885

INOX AISI 304



23071500885 55 1 57 50 Inox Brossé / Geborsteld RVS 0885



09.127-0885



INOX AISI 304

Heurtoir - Deurklopper



091270885 92 56 170 31 Inox Brossé / Geborsteld RVS 0885



09.310-0885



INOX AISI 304

Judas - Kijkgat

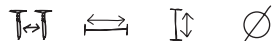

093100885 35 - 50 35 Inox Brossé / Geborsteld RVS 0885

