

locomoson

Specialists in interior & furniture design accessories

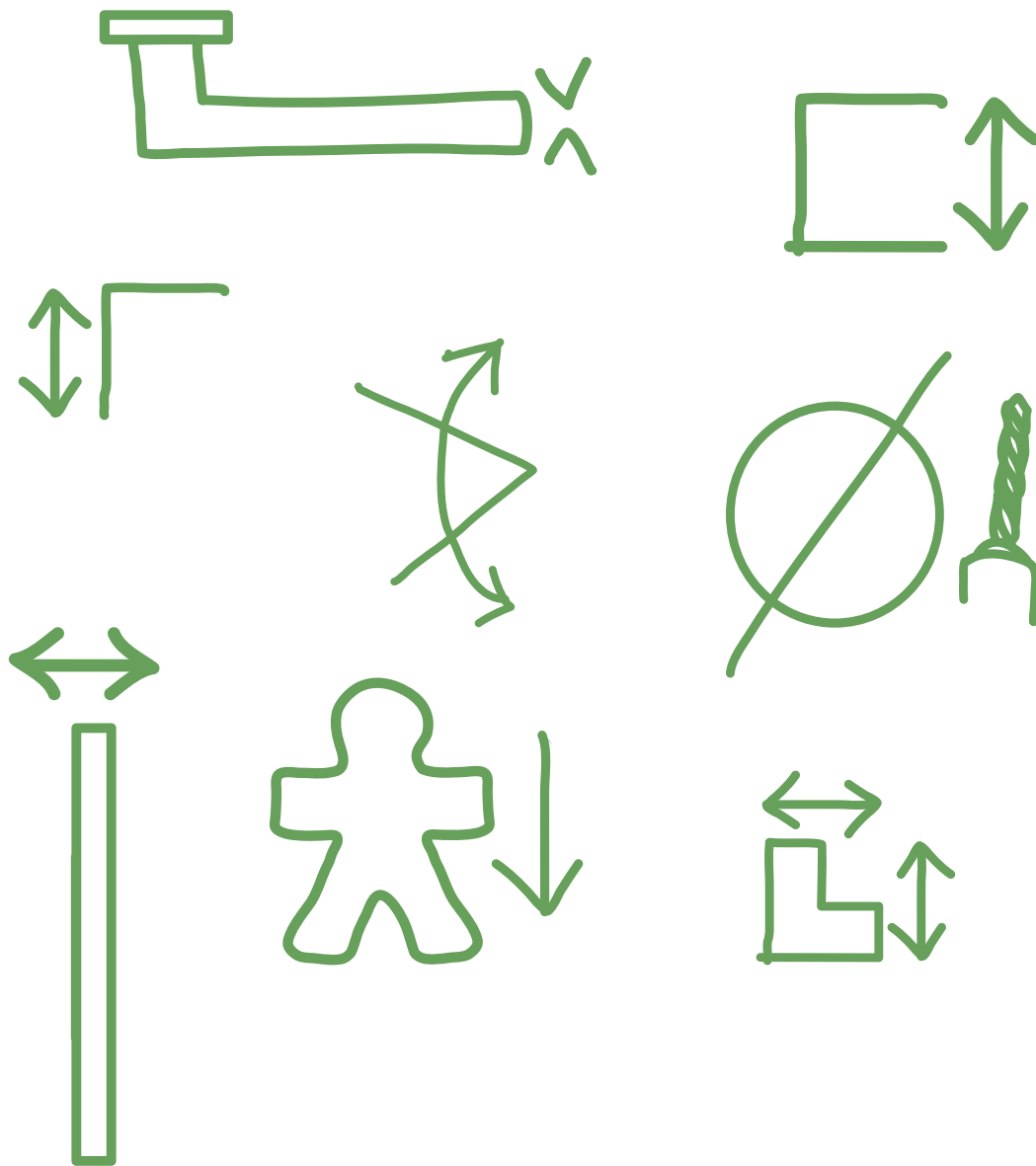

NEW 2023



Les données contenues dans ce catalogue peuvent être modifiées sans avis préalable. Bien que nous ayons pris soin de vérifier l'exactitude des données fournies, Locomoson ne peut en aucun cas assumer la responsabilité pour une erreur ou une omission auprès d'une entreprise, d'une institution ou d'un particulier.

De inhoud van deze catalogus kan door Locomoson zonder voorafgaand bericht gewijzigd worden. Alhoewel Locomoson alles gedaan heeft om de juistheid van de gegevens te verifiëren, kan Locomoson door geen enkele onderneming, instelling of particulier verantwoordelijk gesteld worden voor een vergissing of vergetelheid.



SRL **Locomoson** BV
Avenue Vésale 32 - 1300 Wavre
T. +32 (0) 10 / 88 89 68 - info@locomoson.com

www.locomoson.com

Photography supplied is courtesy of

locomoson



Aujourd'hui, en plus de son activité principale, la société a évolué, en parallèle, vers le travail sur mesure. Locomoson développe et affine ses compétences dans les domaines suivants:

- Atelier de réalisations métalliques sur mesure.
- Fabrication artisanale de poignées de meuble en cuir.
- Peinture de pièces métalliques par thermolaquage.
- Réalisation de pièces par impression 3D en résine, bois et métal.

Dans ce catalogue, vous trouverez notre gamme des produits "standard", pour la plupart en stock et visibles dans notre showroom à Wavre. Pour toute demande particulière, n'hésitez pas à nous contacter sur info@locomoson.com ou +32 (0)10 88 89 68.

Nous vous remercions pour votre collaboration et nous espérons pouvoir continuer à contribuer à vos projets.

L'Équipe Locomoson

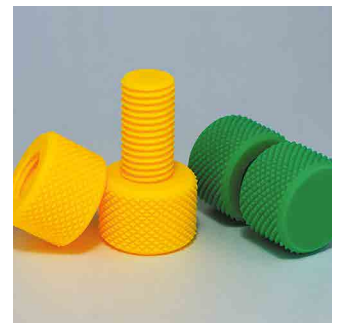
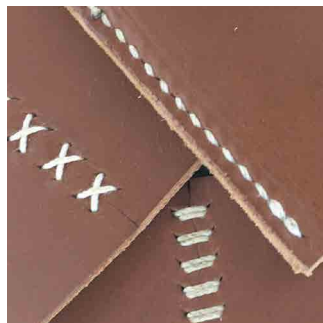

Vandaag, naast haar hoofdactiviteit, heeft Locomoson zich evenals gericht op maatwerk.

De firma blijft haar vaardigheden ontwikkelen en verfijnen op de volgende gebieden:





- Werkplaats voor metaalbewerking en realisaties op maat.
- Handgemaakte lederen meubelgrepen.
- Overschilderen van metalen stukken met poederlak.
- Vervaardiging van objecten door 3D-print in hars, hout en metaal.

In deze catalogus vindt u ons assortiment "standaard" artikelen, waarvan de meesten op voorraad zijn en zichtbaar in onze toonzaal in Waver. Voor speciale verzoeken, aarzel niet om ons te contacteren op info@locomoson.com of +32 (0)10 88 89 68.

Wij danken u voor uw medewerking en hopen steeds een bijdrage te kunnen leveren aan uw projecten.





Het Locomoson-team

37.745 – 0612

						
377450612			31	26	Argent Vieilli / Verouderd Zilver	0612







37.550 – 0612

						
375500612	64	85		25	Argent Vieilli / Verouderd Zilver	0612



37.520 – 0612





						
375200612	128	136	23	17 x 6	Argent Vieilli / Verouderd Zilver	0612



49.500 – T-T – 0885



INOX AISI 304





						
49500960885	96	106	35	10	Inox Brossé / Geborsteld RVS	0885
495001280885	128	138	35	10	Inox Brossé / Geborsteld RVS	0885
495002240885	224	234	35	10	Inox Brossé / Geborsteld RVS	0885
495003200885	320	330	35	10	Inox Brossé / Geborsteld RVS	0885
495005120885	512	522	40	10	Inox Brossé / Geborsteld RVS	0885



49.400 – T-T – 0885







INOX AISI 304

						
49400960885	96	110	30	10	Inox Brossé / Geborsteld RVS	0885
494001280885	128	150	30	10	Inox Brossé / Geborsteld RVS	0885
494002240885	224	260	30	10	Inox Brossé / Geborsteld RVS	0885
494003200885	320	370	30	10	Inox Brossé / Geborsteld RVS	0885







33.560 –

						
335600385	192	260	32	8	Nickel Brossé / Geborsteld Nikkel	0385
335600202	192	260	32	8	Noir Mat / Mat Zwart	0202
335600201	192	260	32	8	Blanc Mat / Mat Wit	0201







33.565 –

						
335650385	192	260	32	8	Nickel Brossé / Geborsteld Nikkel	0385
335650202	192	260	32	8	Noir Mat / Mat Zwart	0202
335650201	192	260	32	8	Blanc Mat / Mat Wit	0201







33.805 – – 0201

						
338051280201	128	136	28	8	Blanc Mat / Mat Wit	0201
338051920201	192	200	28	8	Blanc Mat / Mat Wit	0201
338053200201	320	328	28	8	Blanc Mat / Mat Wit	0201







37.804 – –

						
378041280202	128	136	28	8	Noir Mat / Zwart Mat	0202
378041920202	192	200	28	8	Noir Mat / Zwart Mat	0202
378043200202	320	328	28	8	Noir Mat / Zwart Mat	0202
378044920202	492	500	28	8	Noir Mat / Zwart Mat	0202
378041280385	128	136	28	8	Nickel Brossé / Geborsteld Nikkel	0385
378041920385	192	200	28	8	Nickel Brossé / Geborsteld Nikkel	0385
378043200385	320	328	28	8	Nickel Brossé / Geborsteld Nikkel	0385
378044920385	492	500	28	8	Nickel Brossé / Geborsteld Nikkel	0385
378041280180	128	136	28	8	Chrome Brillant / Glanzend Chroom	0180
378041920180	192	200	28	8	Chrome Brillant / Glanzend Chroom	0180
378043200180	320	328	28	8	Chrome Brillant / Glanzend Chroom	0180
378044920180	492	500	28	8	Chrome Brillant / Glanzend Chroom	0180
378041280381	128	136	28	8	Laiton Brossé / Geborsteld Messing	0381
378041920381	192	200	28	8	Laiton Brossé / Geborsteld Messing	0381
378043200381	320	328	28	8	Laiton Brossé / Geborsteld Messing	0381
378044920381	492	500	28	8	Laiton Brossé / Geborsteld Messing	0381
378041280388	128	136	28	8	Cuivre Brossé / Geborsteld Koper	0388
378041920388	192	200	28	8	Cuivre Brossé / Geborsteld Koper	0388
378043200388	320	328	28	8	Cuivre Brossé / Geborsteld Koper	0388
378044920388	492	500	28	8	Cuivre Brossé / Geborsteld Koper	0388







37.036 – T-T –

					
37036960202	96	103	30	Noir Mat / Mat Zwart	0202
370361600202	160	167	30	Noir Mat / Mat Zwart	0202
370362560202	256	263	30	Noir Mat / Mat Zwart	0202
37036960381	96	103	30	Laiton Brossé / Geborsteld Messing	0381
370361600381	160	167	30	Laiton Brossé / Geborsteld Messing	0381
370362560381	256	263	30	Laiton Brossé / Geborsteld Messing	0381







37.078 – 64-0302

						
37078640302	64	120	38	8	Noir Brossé / Geborsteld Zwart	0302







37.540 –

						
375400202	160	175	25	6	Noir Mat / Mat Zwart	0202
375400614	160	175	25	6	Laiton Vielli / Verouderd Messing	0614
375400610	160	175	25	6	Vieu Fer / Verouderd Ijzer	0610







59.125 –

						
591250202		46	17	34	Noir Mat / Mat Zwart	0202
591250185		46	17	34	Nickel Brillant / Glanzend Nikkel	0185







59.122 – 96 –

						
59122960202	96	120	17	34	Noir Mat / Mat Zwart	0202
59122960185	96	120	17	34	Nickel Brillant / Glanzend Nikkel	0185







37.186 - -

						
37186380302		38	30	Noir Brossé / Geborsteld Zwart	0302	
37186500302		50	30	Noir Brossé / Geborsteld Zwart	0302	
37186380381		38	30	Laiton Brossé / Geborsteld Messing	0381	
37186500381		50	30	Laiton Brossé / Geborsteld Messing	0381	







37.300 - - 0381

						
37300240381		24	23	15	Laiton Brossé / Geborsteld Messing	0381
37300290381		29	29	19	Laiton Brossé / Geborsteld Messing	0381



49.184 -

						
49184TB		35	10	Titanium Black	TB	
49184TG		35	10	Titanium Gold	TG	
49184TCO		35	10	Titanium Copper	TCO	
49184TCH		35	10	Titanium Chocolate	TCH	



Titanium





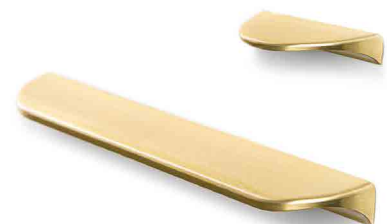

37.750 - - 0381

						
37750320381	32	50	24	Laiton Brossé / Geborsteld Messing	0381	
377501600381	160	178	24	Laiton Brossé / Geborsteld Messing	0381	







37.180 - -

						
37180260202		26	18	Noir Mat / Mat Zwart	0202	
37180410202		41	25	Noir Mat / Mat Zwart	0202	
37180260281		26	18	Laiton Mat / Mat Messing	0281	
37180410281		41	25	Laiton Mat / Mat Messing	0281	
37180260201		26	18	Blanc Mat / Mat Wit	0201	
37180410201		41	25	Blanc Mat / Mat Wit	0201	







37.094 - -

						
37094900202	64	90	17	2	Noir Mat / Mat Zwart	0202
370941800202	128	180	17	2	Noir Mat / Mat Zwart	0202
37094900385	64	90	17	2	Nickel Brossé / Geborsteld Nikkel	0385
370941800385	128	180	17	2	Nickel Brossé / Geborsteld Nikkel	0385



18 mm OK

37.440 -





						
374400201		160	25	14	Blanc Mat / Mat Wit	0201
374400202		160	25	14	Noir Mat / Mat Zwart	0202



18 mm OK







37.460 -

						
374600201		160	25	14	Blanc Mat / Mat Wit	0201
374600202		160	25	14	Noir Mat / Mat Zwart	0202

18 mm OK

37.780 - - 0202





						
37780320202	32	45	45		Noir Mat / Mat Zwart	0202
377801600202	160	173	45		Noir Mat / Mat Zwart	0202



18 mm OK

49.781 - 0885



						
497810885		172	58	2	Inox Brossé / Geborsteld RVS	0885

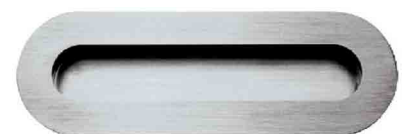

18 mm OK

37.017 – 0381

	T⇌T	∅	I⇌I		
370170381		17	28	Laiton Brossé / Geborsteld Messing	0381



33.140 –

	T⇌T	⇌	∅	I⇌I	
331400202			16-31	26	Noir Mat / Mat Zwart 0202
331400181			16-31	26	Laiton Brillant / Glanzend Messing 0181
331400180			16-31	26	Chrome Brillant / Glanzend Chroom 0180
331400385			16-31	26	Nickel Brossé / Geborsteld Nikkel 0385



37.118 –

	T⇌T	⇌	I⇌I	📦	
371180385			25	15	Nickel Brossé / Geborsteld Nikkel 0385
371180202			25	15	Noir Mat / Mat Zwart 0202



37.745 –

	T⇌T	⇌	∅	I⇌I	
377450202			31	26	Noir Mat / Mat Zwart 0202
377450381			31	26	Laiton Brossé / Geborsteld Messing 0381
377450614			31	26	Laiton Vieilli / Verouderd Messing 0614
377450612			31	26	Argent Vieilli / Verouderd Zilver 0612



49.180 – ∅ –

	T⇌T	⇌	∅	I⇌I	
4918020TB			20	15	Titanium Black TB
4918025TB			25	20	Titanium Black TB
4918030TB			30	25	Titanium Black TB
4918020TG			20	15	Titanium Gold TG
4918025TG			25	20	Titanium Gold TG
4918030TG			30	25	Titanium Gold TG
4918020TCO			20	15	Titanium Copper TCO
4918025TCO			25	20	Titanium Copper TCO
4918030TCO			30	25	Titanium Copper TCO
4918020TCH			20	15	Titanium Chocolate TCH
4918025TCH			25	20	Titanium Chocolate TCH
4918030TCH			30	25	Titanium Chocolate TCH



Titanium



POIGNÉES DE MEUBLE – MEUBELGREPEN

49.891 –

INOX AISI 304

	T-T	Ø	key	arrow		
49891350885	35	31	2	Inox Brossé / Geborsteld RVS	0885	
49891500885	50	46	2	Inox Brossé / Geborsteld RVS	0885	
49891700885	70	66	2	Inox Brossé / Geborsteld RVS	0885	
4989135TB	35	31	2	Titanium Black	TB	
4989150TB	50	46	2	Titanium Black	TB	
4989170TB	70	66	2	Titanium Black	TB	
4989135TG	35	31	2	Titanium Gold	TG	
4989150TG	50	46	2	Titanium Gold	TG	
4989170TG	70	66	2	Titanium Gold	TG	
4989135TCO	35	31	2	Titanium Copper	TCO	
4989150TCO	50	46	2	Titanium Copper	TCO	
4989170TCO	70	66	2	Titanium Copper	TCO	
4989135TCH	35	31	2	Titanium Chocolate	TCH	
4989150TCH	50	46	2	Titanium Chocolate	TCH	
4989170TCH	70	66	2	Titanium Chocolate	TCH	

18 mm OK



Titanium

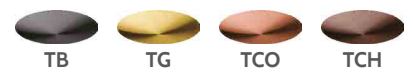

49.892 –

INOX AISI 304

	T-T	square	key	arrow		
49892350885	35	31	2	Inox Brossé / Geborsteld RVS	0885	
49892500885	50	46	2	Inox Brossé / Geborsteld RVS	0885	
49892700885	70	66	2	Inox Brossé / Geborsteld RVS	0885	
4989235TB	35	31	2	Titanium Black	TB	
4989250TB	50	46	2	Titanium Black	TB	
4989270TB	70	66	2	Titanium Black	TB	
4989235TG	35	31	2	Titanium Gold	TG	
4989250TG	50	46	2	Titanium Gold	TG	
4989270TG	70	66	2	Titanium Gold	TG	
4989235TCO	35	31	2	Titanium Copper	TCO	
4989250TCO	50	46	2	Titanium Copper	TCO	
4989270TCO	70	66	2	Titanium Copper	TCO	
4989235TCH	35	31	2	Titanium Chocolate	TCH	
4989250TCH	50	46	2	Titanium Chocolate	TCH	
4989270TCH	70	66	2	Titanium Chocolate	TCH	

18 mm OK





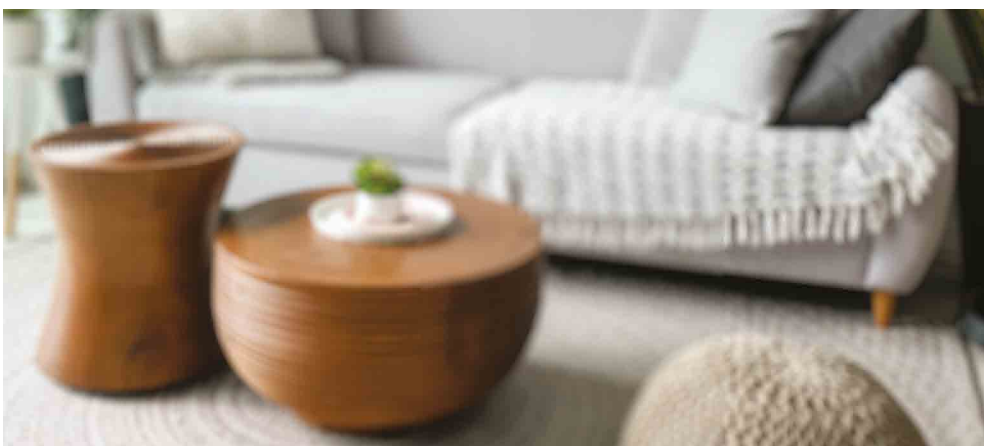
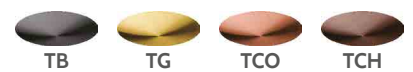

Titanium





24.930 – –

					
24930400282	1,2	40	37	Alu Mat / Mat Alu	0282
249301470282	1,2	147	37	Alu Mat / Mat Alu	0282
249302470282	1,2	247	37	Alu Mat / Mat Alu	0282
24930400285	1,2	40	37	Nickel Mat / Mat Nikkel	0285
249301470285	1,2	147	37	Nickel Mat / Mat Nikkel	0285
249302470285	1,2	247	37	Nickel Mat / Mat Nikkel	0285
24930400202	1,2	40	37	Noir Mat ANDZ / Zwart Mat ANDZ	0202
249301470202	1,2	147	37	Noir Mat ANDZ / Zwart Mat ANDZ	0202
249302470202	1,2	247	37	Noir Mat ANDZ / Zwart Mat ANDZ	0202

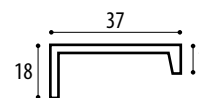

sur mesure
op maat
max. 3 m



ARCHITECTURAL
HARDWARE



200.000 CYCLES

EN1935 2 7 2 0 1 4 0 7



CHARNIERES ET PIVOTS - SCHARNIEREN EN DRAAIDEURASSEN

49.356-3D-120-  



493563D1200202	Noir / Zwart	0202
493563D1208079	Gris / Grijs	8079

200.000 CYCLES

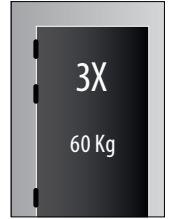
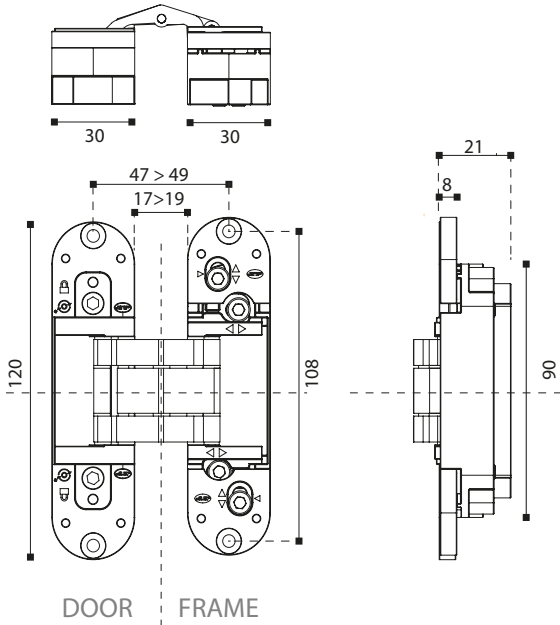

RAL 9006

RAL 9016

RAL 9005



Poids
Gewicht (kg)

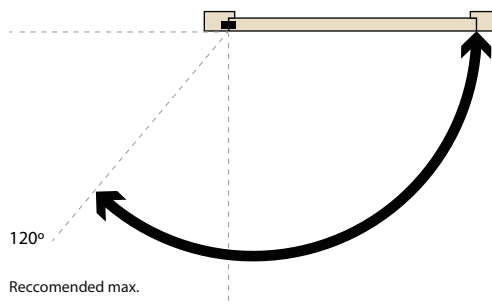
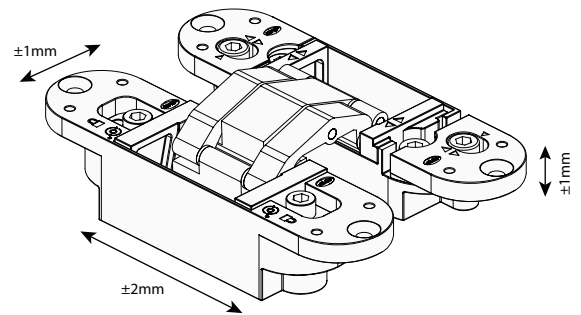
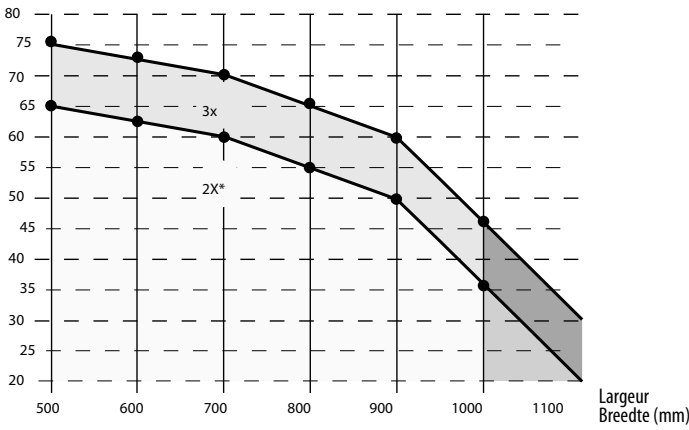

49.356 - 3D - 150-



493563D1500201	Blanc / Wit	0201
493563D1500202	Noir / Zwart	0202
493563D1508079	Gris / Grijs	8079

200.000 CYCLES

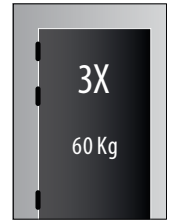
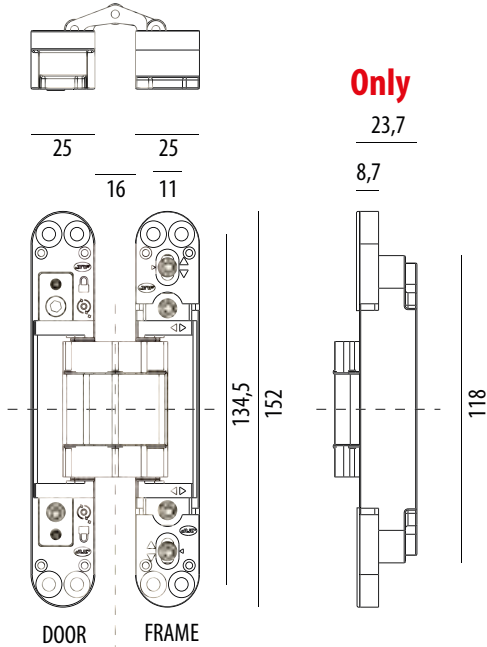

RAL 9006

RAL 9016

RAL 9005

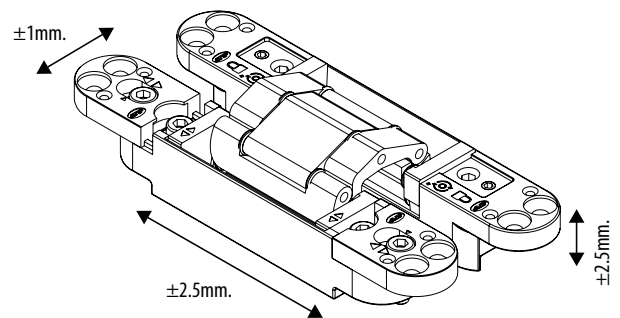
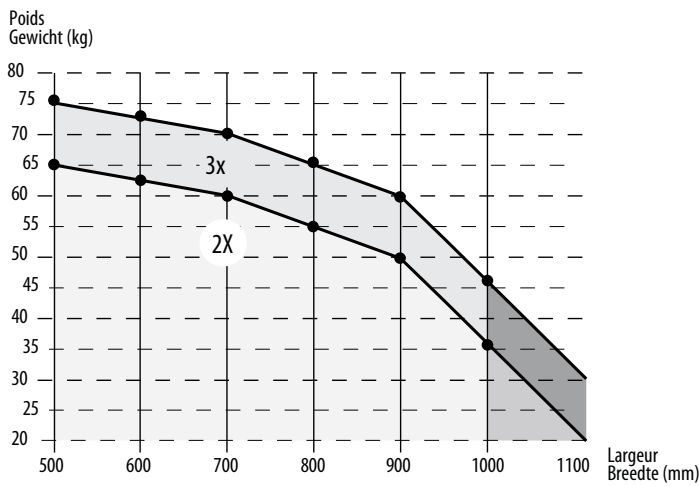

FIREPROOF

49.356 - KI - 150

49356KI150

Kit intumescent
Schuimvormend kit

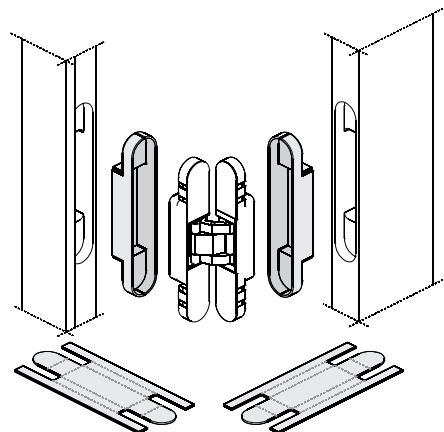

49.356 - 3D - 175-

493563D1750202	Noir / Zwart	0202
493563D1758079	Gris / Grijs	8079



200.000 CYCLES

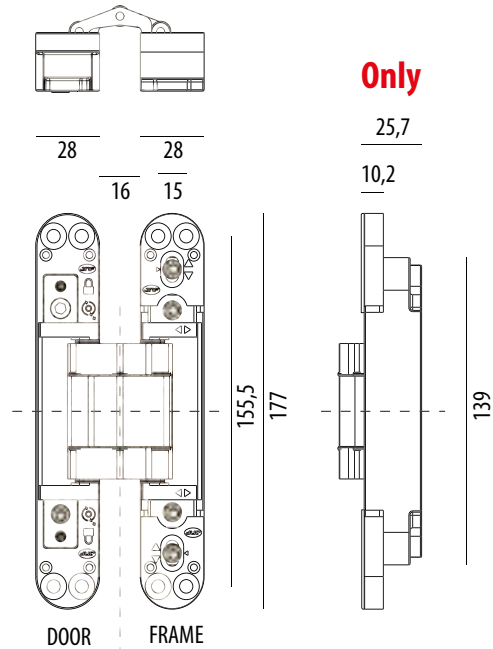

RAL 9006

RAL 9005



Poids
Gewicht (kg)

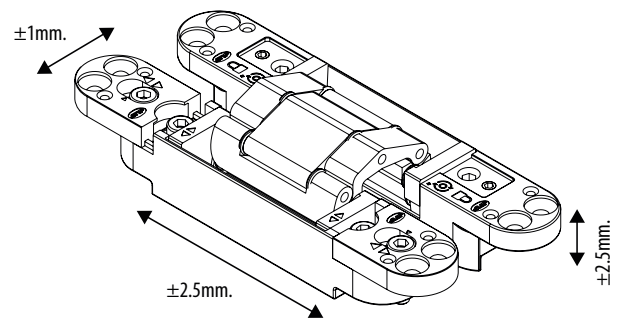
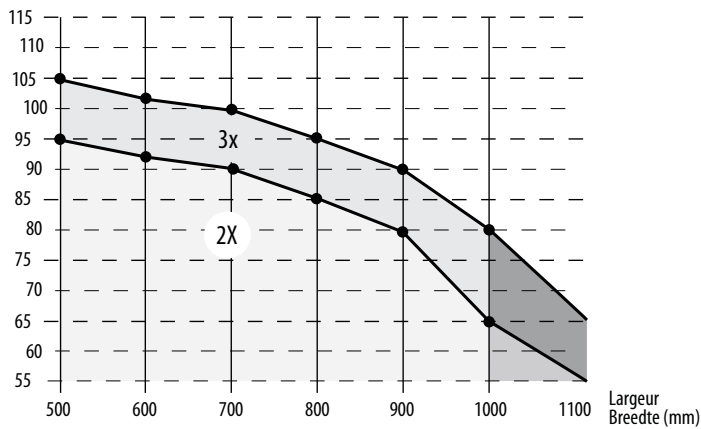

49.356 - KI - 175

49356KI175

Kit intumescent
Schuimvormend kit

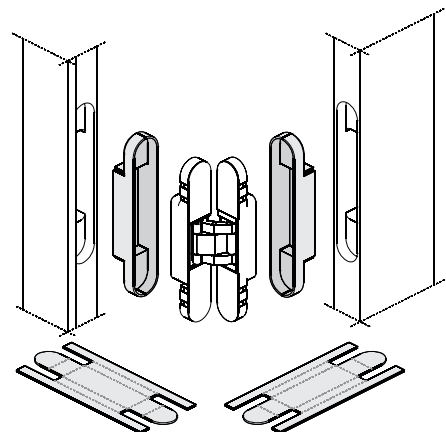

49.356 - 3D - 245-



493563D2450202	Noir / Zwart	0202
493563D2458079	Gris / Grijs	8079



200.000 CYCLES

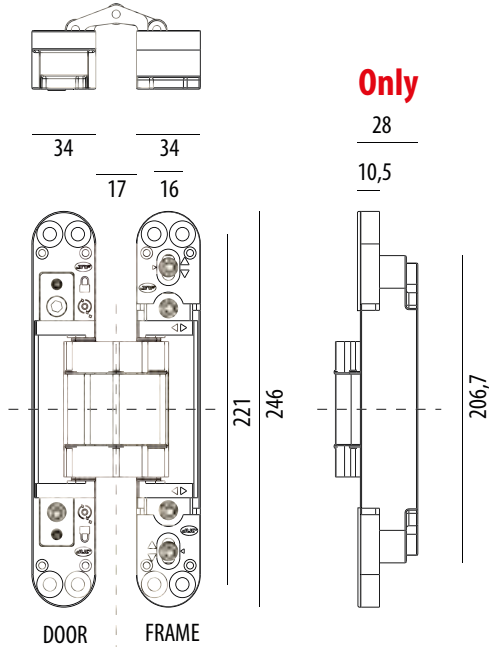

RAL 9006

RAL 9005



Poids
Gewicht (kg)

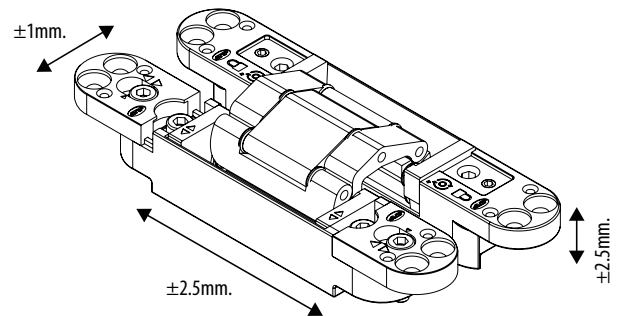
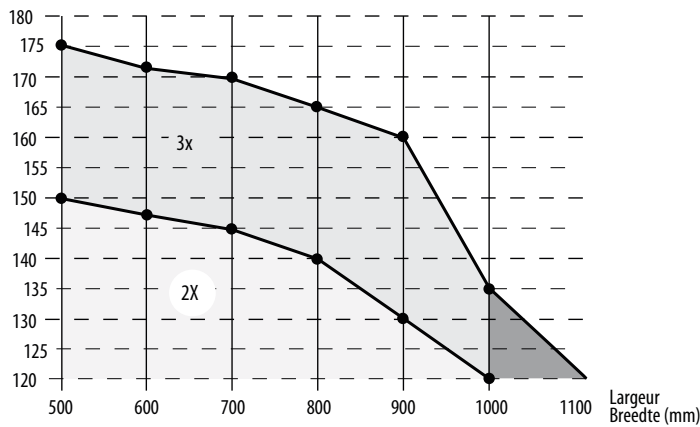

FIREPROOF

49.356 - KI - 245

49356KI245

Kit intumescent
Schuimvormend kit

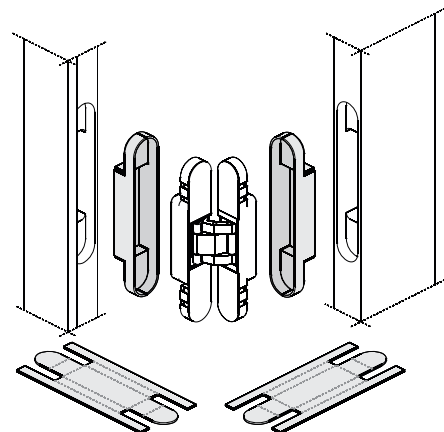

SERRURES - SLOTEN

47.698- 



INOX AISI 304

Serrure pour porte coulissante - Slot voor schuifdeur



476980885

0885

476980202

0202

476980381

0381

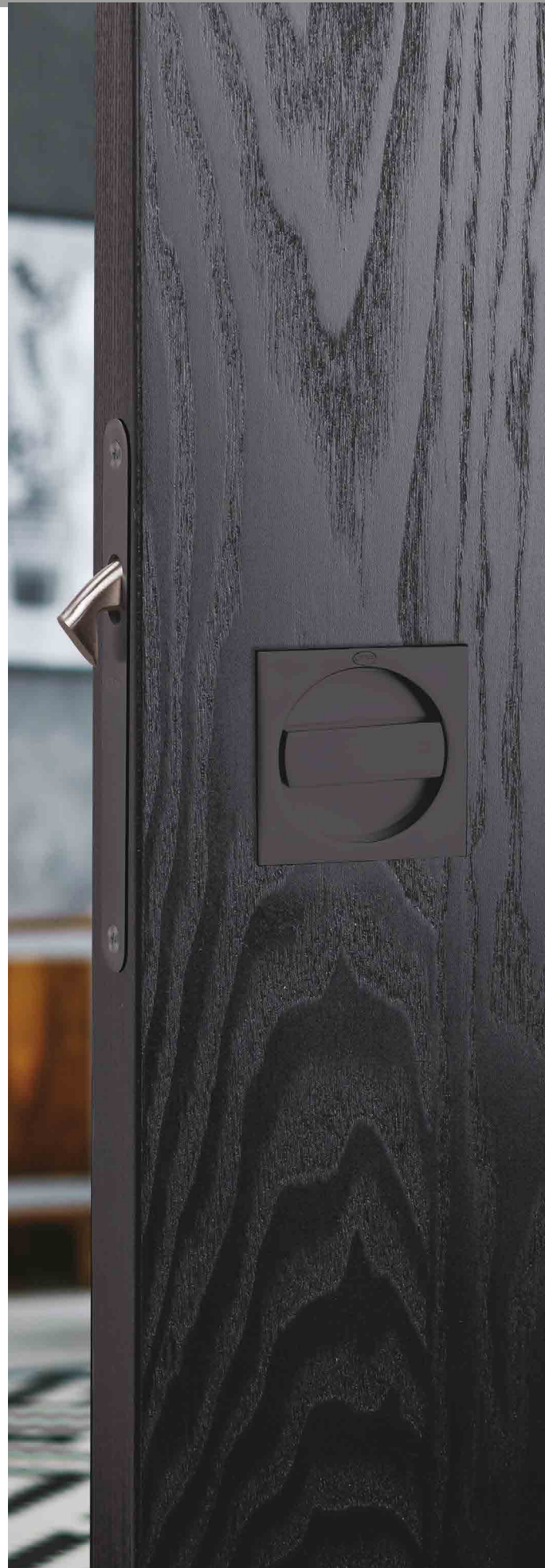
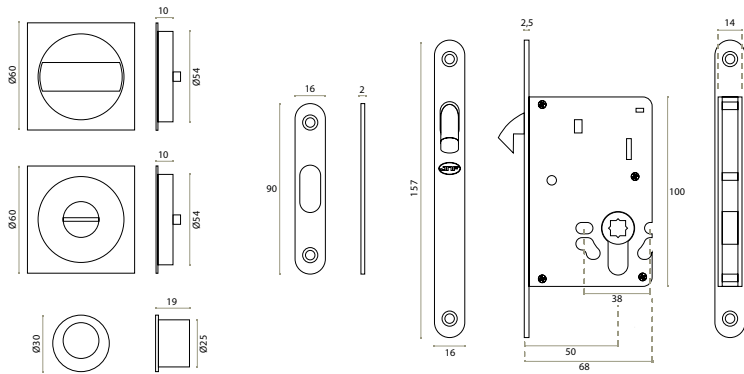



ARCHITECTURAL
HARDWARE



09.945

09945 Pivot hydraulique pour porte en bois / Hydraulisch draaispil voor houten deur



Soft Close

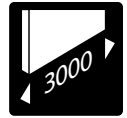

47.710

30kg

Aimants - Magneten

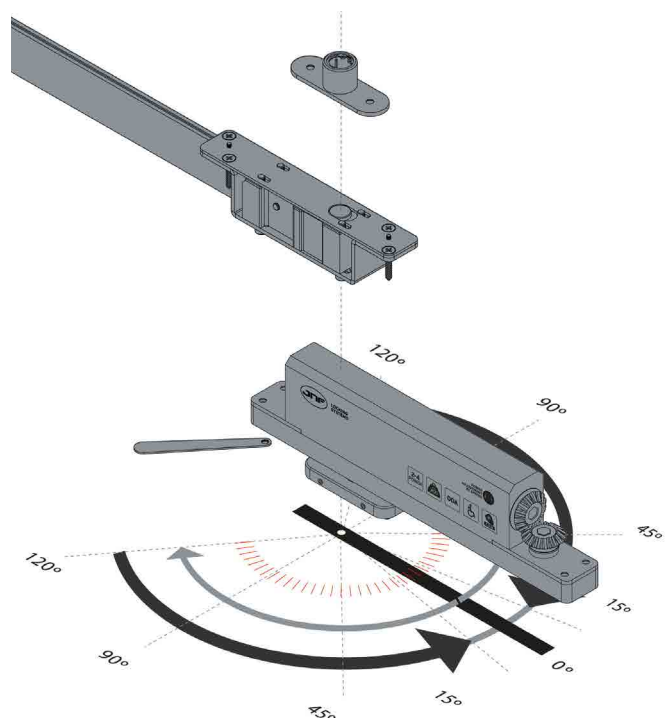



ARCHITECTURAL
HARDWARE

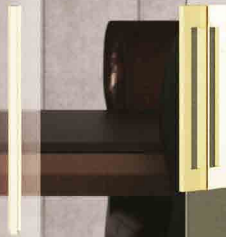

89.319 -



Charnière hydraulique mur / verre - Hydraulische scharnier voor mur / glas

893190885	Inox Brossé / Geborsteld RVS	0885
893190185	Inox Poli / Gepolijst RVS	0185
89319TB	Titanium Black	TB
89319TG	Titanium Gold	TG
89319TCO	Titanium Cooper	TCO
89319TCH	Titanium Chocolate	TCH



Soft Close

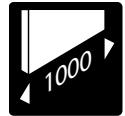

Titanium

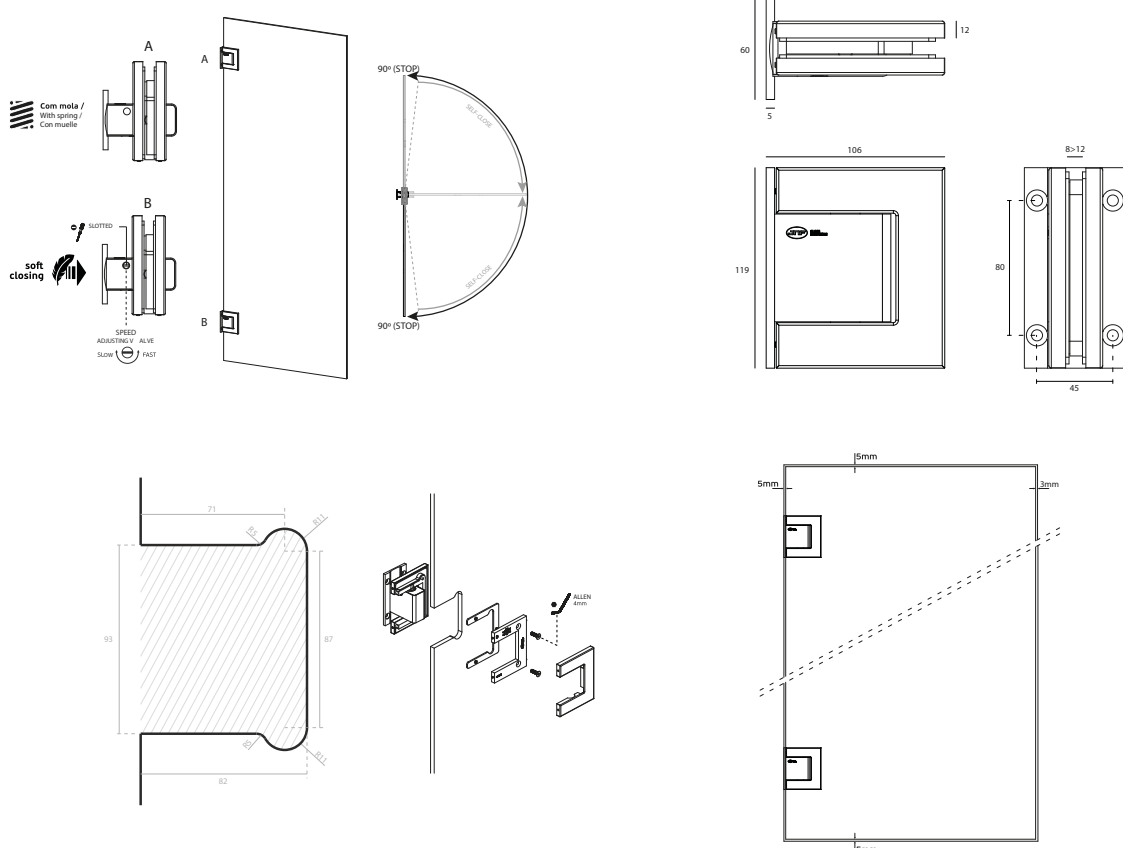



ARCHITECTURAL
HARDWARE

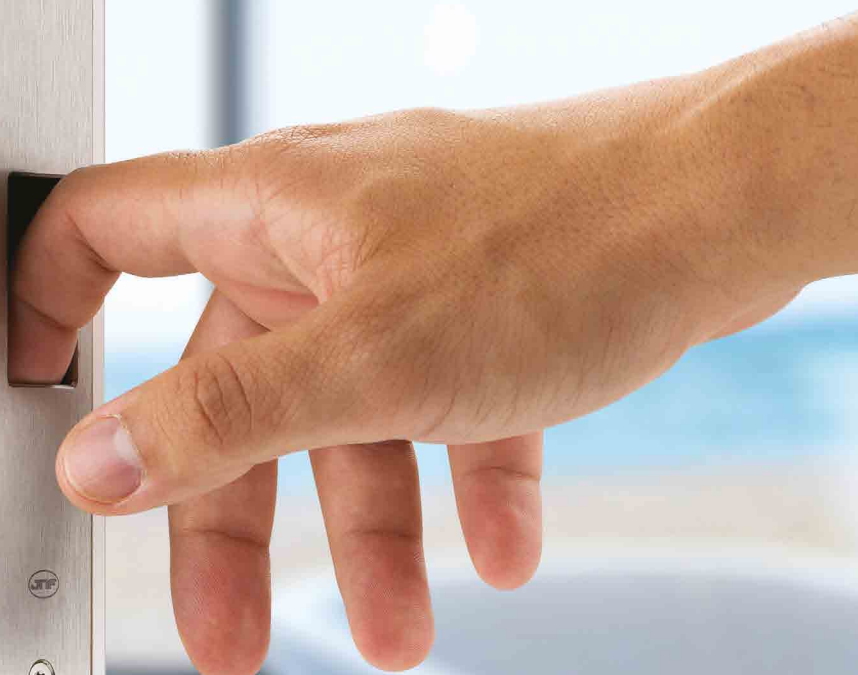

SERRURES - SLOTEN

47.925 -



Magnetic sliding door lock



479250885	Inox Brosé / Geborsteld RVS	0885
47925TB	Titanium Black	TB
47925TG	Titanium Gold	TG
47925TCO	Titanium Cooper	TCO
47925TCH	Titanium Chocolate	TCH



Titanium

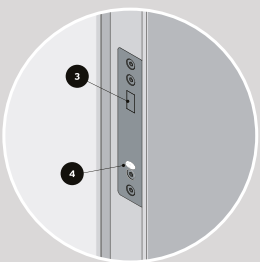
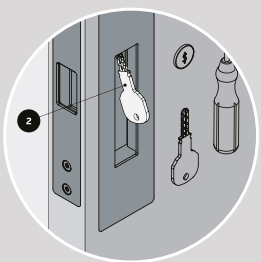
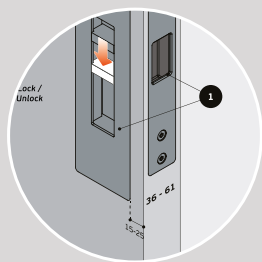
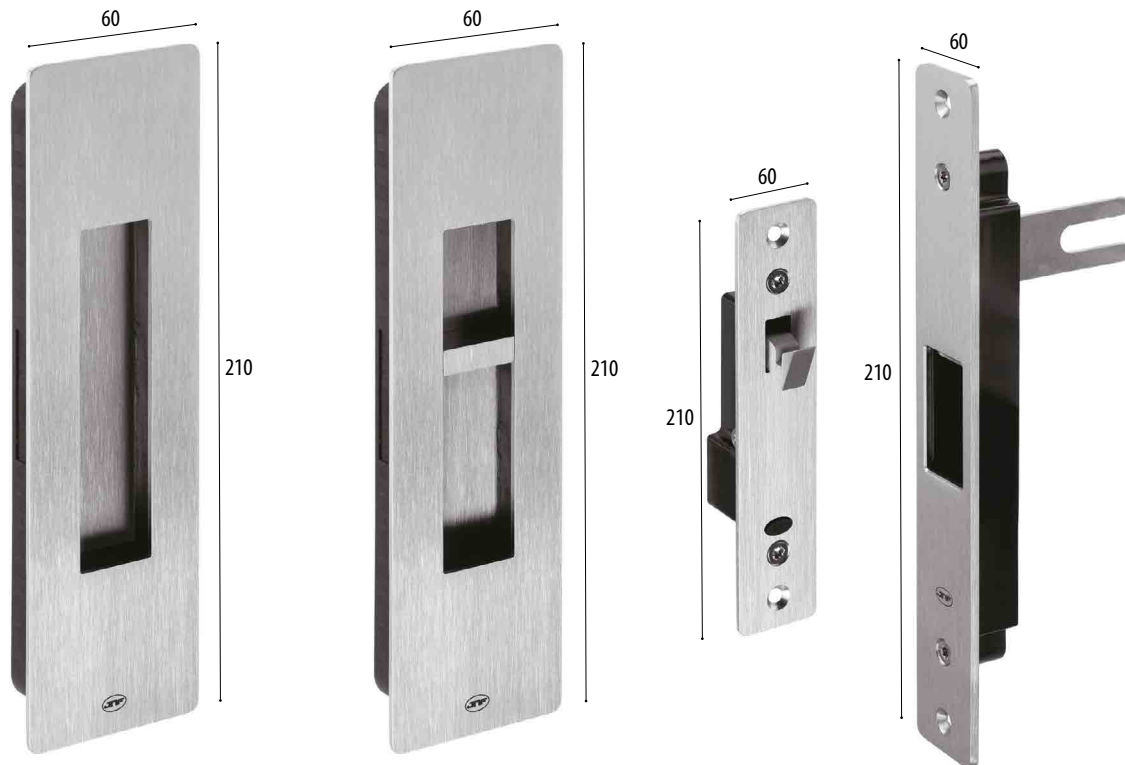

- 1 Ergonomic handle with chamfer / Puxador ergonómico com chanfro
- 2 Unlocking from the outside in case of an emergency / Desbloqueio pelo exterior em caso de emergência
- 3 Anti-vandalization due to misuse and doesn't block involuntarily / Anti-vandalização por má utilização e não bloqueia de forma involuntária
- 4 Nylon stopper / Batente de nylon

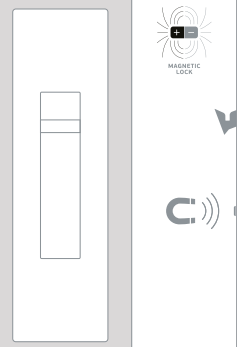



ARCHITECTURAL
HARDWARE

HYDRAULIC



CHARNIERES ET PIVOTS - SCHARNIEREN EN DRAAIDEURASSEN



2000

2000 / 2500 / 3000

IN.15.510.2000
IN.15.510.2500
IN.15.510.3000
 Complete system for 2 leafs, reversible.
 Doors not included.

4000

2000 / 2500 / 3000

IN.15.511.2000
IN.15.511.2500
IN.15.511.3000
 Complete system for 4 leafs.
 Doors not included.

WITH AUTO HYDRAULIC
 CLOSING DEVICE
 COM FECHO HIDRÁULICO
 AUTOMÁTICO

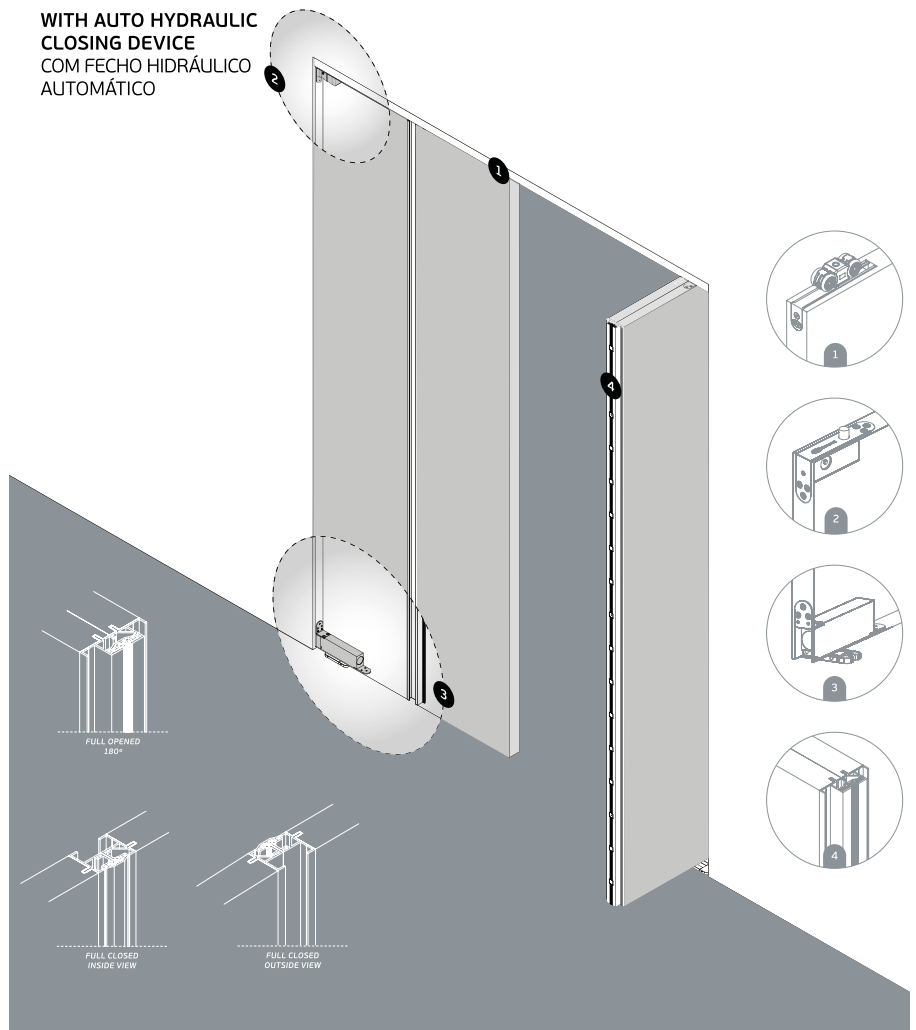



ARCHITECTURAL
HARDWARE

CONSIERGE

AUTOMATIC DOOR OPERATOR



FERME-PORTES - DEURSLUITERS



21.900 -



219000201	Blanc / Wit	0201
219000202	Noir / Zwart	0202
219008079	Gris / Grijs	8079

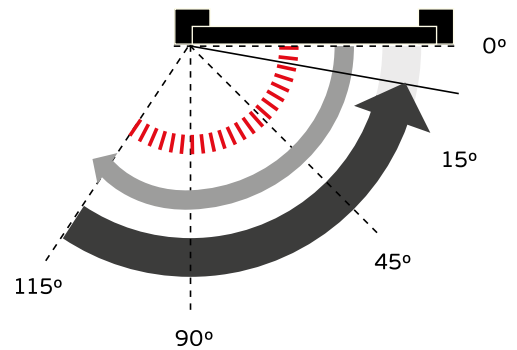
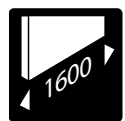





- Opening (max. 115°)
- Closing speed
- Final closing speed (adjustable)
- Hold open time (adjustable)



37.890 -



Portemanteaux - Kapstok

					
378900202	28		40-97	Noir Mat / Zwart Mat	0202
378900201	28		40-97	Blanc Mat / Wit Mat	0201
378902214	28		40-97	Noyer / Notelaar	2214
378902002	28		40-97	Chêne / Eikenhout	2002



37.900 - 060-0381-2002





Portemanteaux - Kapstok

					
3790006003812002	64		60	Laiton - Chêne / Messing - Eikenhout	0381-2002



37.900 - 090-0202-2214





Portemanteaux - Kapstok

					
3790009002022214	67		90	Noir - Noyer / Zwart - Notelaar	0202-2214



37.900 - 120-0381-0202





Portemanteaux - Kapstok

					
3790012003810202	70		120	Laiton - Noir / Messing - Zwart	0381-0202



37.892 -





Portemanteaux - Kapstok

					
378920202	57		50-16	Noir Mat / Zwart Mat	0202
378920381	57		50-16	Laiton Brossé / Geborsteld Messing	0381
378920201	57		50-16	Blanc Mat / Wit Mat	0201



37.888 -

Portemanteaux - Kapstok

					
378880682	50		21	Look Inox	0385
378880381	50		21	Laiton Brossé / Geborsteld Messing	0381
378880302	50		21	Noir Brossé / Geborsteld Zwart	0302



Également
disponible en
blanc

Ook leverbaar
in wit

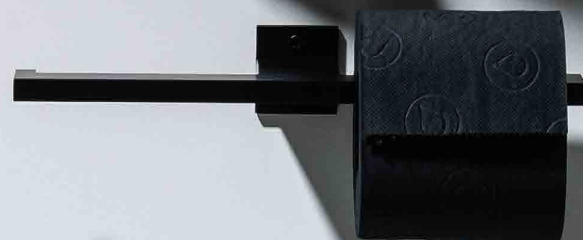

49.001 - T↔T - 0202

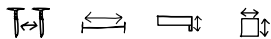

Porte Serviettes - Handdoekdrager

490012500202	250	Noir Mat / Zwart Mat	0202
490014250202	425	Noir Mat / Zwart Mat	0202
490016000202	600	Noir Mat / Zwart Mat	0202



49.002 - 1 - 0202

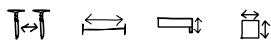

Support Papier WC - WC Rolhouder

4900210202		Noir Mat / Zwart Mat	0202
------------	--	----------------------	------



49.002 - 2 - 0202

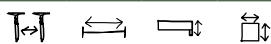

Support Papier WC - WC Rolhouder

4900220202		Noir Mat / Zwart Mat	0202
------------	--	----------------------	------



49.005 - 1 - 0202

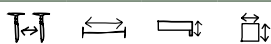

Brosse WC - WC Borstel

4900510202		Noir Mat / Zwart Mat	0202
------------	--	----------------------	------



49.005 - 2 - 0202

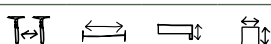

Brosse WC Murale - WC Murale Borstel

4900520202		Noir Mat / Zwart Mat	0202
------------	--	----------------------	------

49.007 - 0202

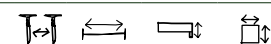

Crochet - Haakje

490070202		Noir Mat / Zwart Mat	0202
-----------	--	----------------------	------



49.006 - 0202

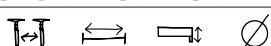

Porte-savon - Zeephouder

490060202		Noir Mat / Zwart Mat	0202
-----------	--	----------------------	------





45.012 - ST02

45.009 - ST02

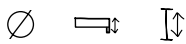

Réserve Papier WC - WC Rolhouder Reserve

45009ST02

120

160

Noir Structuré / Gestructureerd Zwart

ST02



45.010 - ST02

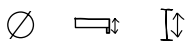

Brosse WC - WC Borstel

45010ST02

120

400

Noir Structuré / Gestructureerd Zwart

ST02



45.001 - 600 - ST02

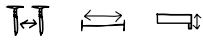

Porte Serviettes - Handdoekdrager

45001600ST02	553	600	60	Noir Structuré / Gestructureerd Zwart	ST02
--------------	-----	-----	----	---------------------------------------	------

45.002 - ST02

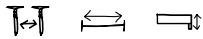

Support Papier WC - WC Rolhouder

45002ST02	20	120	70	Noir Structuré / Gestructureerd Zwart	ST02
-----------	----	-----	----	---------------------------------------	------

45.003 - ST02

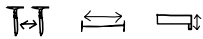

Crochet - Haakjes

45003ST02	20	40	30	Noir Structuré / Gestructureerd Zwart	ST02
-----------	----	----	----	---------------------------------------	------

45.004 - 200 - ST02

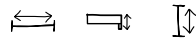

Etagère - Rek

45004200ST02	200	100	100	Noir Structuré / Gestructureerd Zwart	ST02
--------------	-----	-----	-----	---------------------------------------	------

45.004 - 400 - ST02

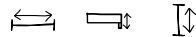

Etagère - Rek

45004400ST02	400	100	100	Noir Structuré / Gestructureerd Zwart	ST02
--------------	-----	-----	-----	---------------------------------------	------

45.011 - ST02

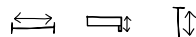

Etagère - Rek

45011ST02	280	100	150	Noir Structuré / Gestructureerd Zwart	ST02
-----------	-----	-----	-----	---------------------------------------	------



45.006 - - ST02

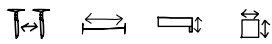

Penderie - Hangrek

45006500ST02	465	500	260	35x35	Noir Structuré / Gestructureerd Zwart	ST02
450061000ST02	965	1000	260	35x35	Noir Structuré / Gestructureerd Zwart	ST02



45.007 - 3 - ST02

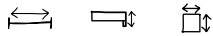

3 Cintres - 3 Kleerhanger

450073ST02			6x6	Noir Structuré / Gestructureerd Zwart	ST02
------------	--	--	-----	---------------------------------------	------



45.008 - ST02



Crochet - Haakjes

45008ST02			6x6	Noir Structuré / Gestructureerd Zwart	ST02
-----------	--	--	-----	---------------------------------------	------



45.005 - - ST02



Porte chaussures - Schoenenrek

45005500ST02	500	100	350	Noir Structuré / Gestructureerd Zwart	ST02
450051000ST02	1000	100	350	Noir Structuré / Gestructureerd Zwart	ST02





A series of 25 horizontal, light gray lines spaced evenly down the page, providing a template for writing.

- Poignées de meuble
- Accessoires
- Signalétique
- Béquilles et rosaces
- Arrêt de porte
- Charnières et pivots
- Serrures
- Kit porte coulissantes
- Tirants de porte
- Think. Connect. Build
- Accessoires sanitaires
- Accessoires 
- Mecabix
- Glass Hardware & Cabling
- Dressing
- Meubelgrepen
- Accessoires
- Pictogrammen
- Deurkrukken en rozetten
- Deurstop
- Scharnier en draaideurassen
- Sloten
- Schuifdeurkit
- Deurtrekkers
- Think. Connect. Build
- Sanitaire accessoires
- Accessoires 
- Mecabix
- Glass Hardware & Cabling
- Dressing

SRL **Locomoston** BV

Avenue Vésale 32 - 1300 Wavre

T. +32 (0)10 88 89 68 - info@locomoston.com

www.locomoston.com



www.facebook.com/Locomoston